



INTERIOR DESIGN



reddot winner 2024

archiproducts®
AWARDS
WINNER

KLOSS

Design | Kauppi & Kauppi



KLOSS recycling system reflects our need to separate and organise, putting the right materials in the right bins for recycling. What we used to define as waste is now a material resource that can be reused. All interiors and situations have different conditions, with KLOSS there are almost endless possibilities to build whatever form and function is needed, in any RAL colour you wish. Creative and playful recycling units for all environments.

"Modularity" is the basic idea and design essence of KLOSS. A vast and highly flexible, connectable modular system for recycling. Three different modules, made of steel, provide endless possibilities and shapes. Choice of modules and configuration, together with the choice of colour, top, lid and accessories - gives the recycling unit its final shape and expression.

The KLOSS recycling system grows with two new smaller module sizes and several new features - elevating itself from a modular collection to a larger recycling furniture infrastructure.

The new additions KLOSS Small and KLOSS Mini enable waste sorting everywhere - from large spaces and interiors to smaller and closer situations. The smaller KLOSS sizes fit well into any context where sorting modules are needed, even where space may be limited or where the bins need to harmonise with the overall interior style. KLOSS can blend in or characterise a space depending on the choice of size, composition, colour and accessories.



KLOSS recycling system has been assessed by Byggsvarubedömningen and received the highest rating "Recommended".



Last updated: 2024.04.05



KLOSS Wine red RAL 3005, **KLOSS Small** Old pink RAL 3014, **KLOSS Mini** Pearl white RAL 1013



KLOSS Small Pearl white RAL 1013 with legs,
KLOSS Mini Old pink RAL 3014 with leg stand

Sustainability and materials

- The modules are made of 20 % recycled steel with long durability.
- Circular product: modules can be disassembled and replaced, refreshed, repaired, refurbished and recycled.
- The steel body is made in parts that are joined together by the click method and are detachable for renovation.
- Container with base insert allows the use of paper bag.
- Container and base insert is made of 100 % recycled ABS plastic.
- The rubber inlet is made of black bio-based ECO EPDM rubber.
- KLOSS can hold up to 62-68 L, Small 32-35 L and Mini 11-13 L

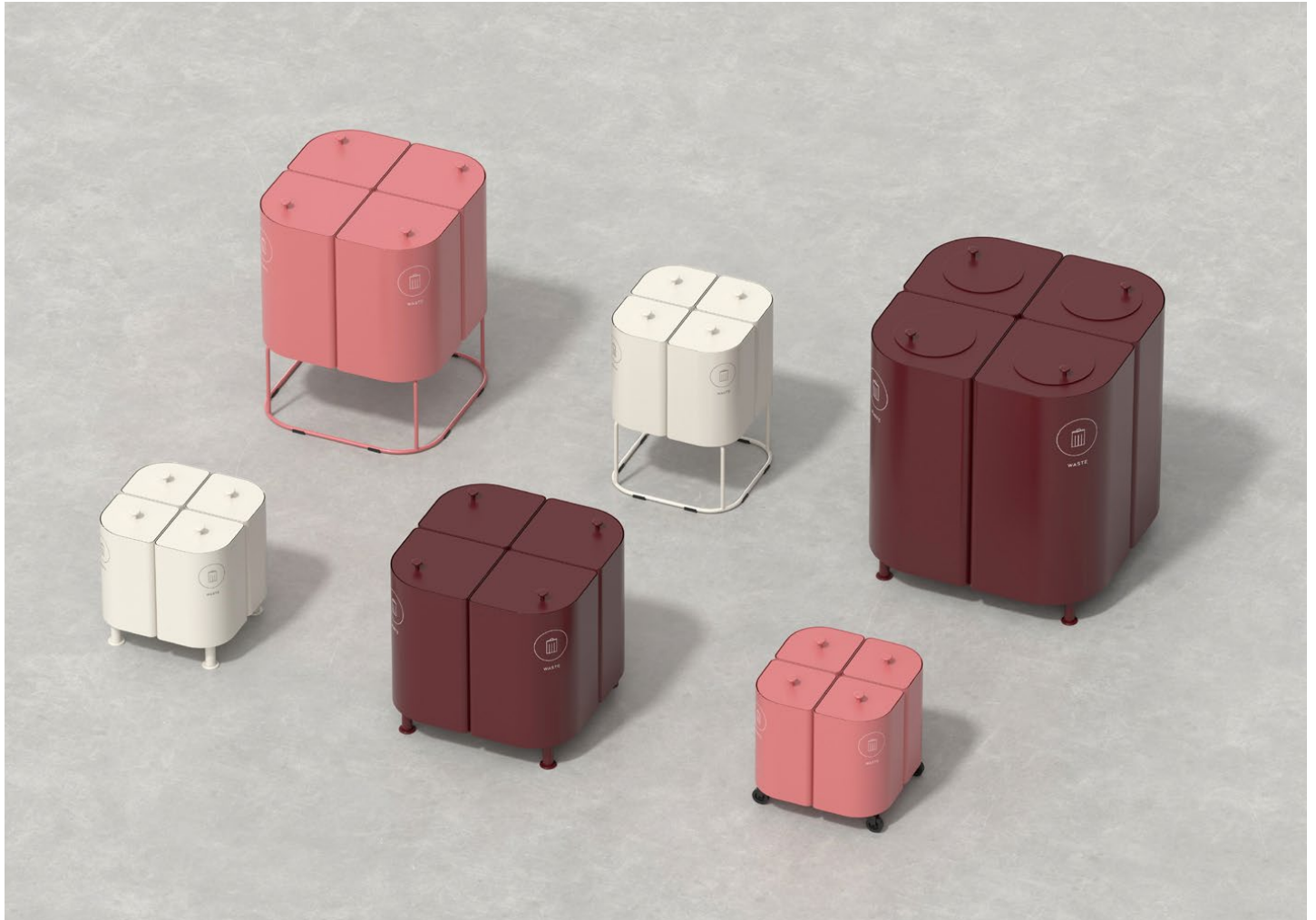

KLOSS Small Pearl white RAL 1013 with leg stand





KLOSS are connected together with connection holes on each frame

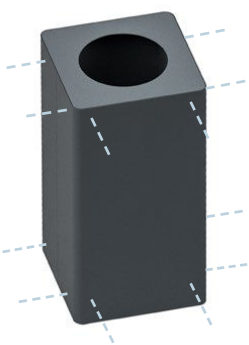

M1 - 6 connection holes

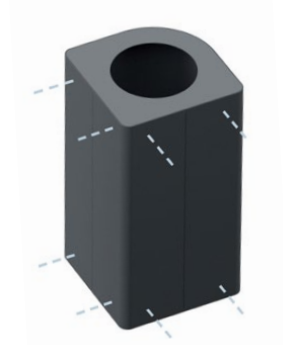

M2 - 4 connection holes



M3 - 2 connection holes

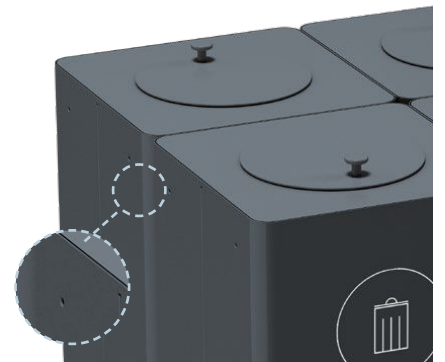

NOTE! The connection holes are included on all our frames and will be visible depending on which set you have.



Frame/Top/Wall bracket/Knob/Leg: Powder coated steel sheet

Lid: Powder coated steel sheet and compact laminate

Container & Base insert: 100% recycled ABS plastic

Rubber insert: Black ECO EPDM rubber

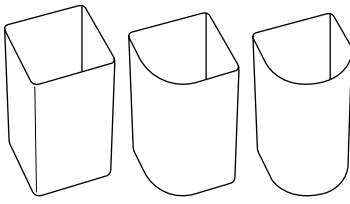
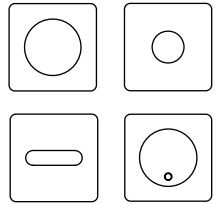
How to order KLOSS:

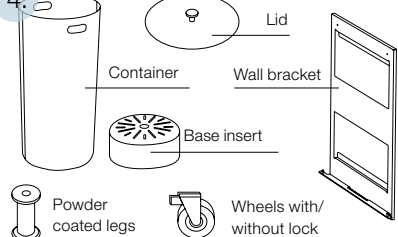
<p>1.</p> 	<p>2.</p> 	<p>3.</p> 	<p>4.</p> 
<p>Choose frame and colour Bin with adjustable feet. Integrated bag holder included.</p>	<p>Choose top and colour Available with lid & lock.</p>	<p>Choose symbol Order more symbols per unit, if the product is to be placed on a standalone basis</p>	<p>Choose accessories: legs or wheels, wall bracket, lid, container and base insert. Integrated bag holder included in all models.</p>

KLOSS Frame in powder coated steel sheet 1 mm. Width 360 mm, Height 700 mm, Depth 360 mm.

Markings on the illustrations refer to the visible mounting lines of the connection holes.

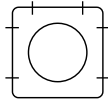

M1: Square frame
Holds approx. 68 L

Colour	Art no.
RAL 9010 White	32100001
RAL 7032 Warm Grey	32100020
RAL 7016 Anthracite	32100004
RAL 5023 Brilliant blue	32100021
RAL 1013 Pearl white	32100022
RAL 6013 Olive	32100023
RAL 6020 Forest green	32100024
RAL 8014 Chocolate	32100025
RAL 1017 Saffron	32100026
RAL 3014 Old pink	32100027
RAL 3005 Wine red	32100028

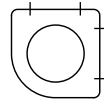

M2: Frame with one round corner
Holds approx. 65 L

Colour	Art no.
RAL 9010 White	32200001
RAL 7032 Warm Grey	32200020
RAL 7016 Anthracite	32200004
RAL 5023 Brilliant blue	32200021
RAL 1013 Pearl white	32200022
RAL 6013 Olive	32200023
RAL 6020 Forest green	32200024
RAL 8014 Chocolate	32200025
RAL 1017 Saffron	32200026
RAL 3014 Old pink	32200027
RAL 3005 Wine red	32200028



M3: Frame with a straight side and rounded front
Holds approx. 62 L

Colour	Art no.
RAL 9010 White	32300001
RAL 7032 Warm Grey	32300020
RAL 7016 Anthracite	32300004
RAL 5023 Brilliant blue	32300021
RAL 1013 Pearl white	32300022
RAL 6013 Olive	32300023
RAL 6020 Forest green	32300024
RAL 8014 Chocolate	32300025
RAL 1017 Saffron	32300026
RAL 3014 Old pink	32300027
RAL 3005 Wine red	32300028

Any RAL colour at an additional cost, contact TreCe.

KLOSS Colours



White Warm Grey Anthracite Brilliant blue Pearl white Olive Forest green Chocolate Saffron Old pink Wine red

Top: The Top is available in 4 variants with different external shapes, depending on the frame chosen. On the top of the fixed lid there is a knob in the same colour as the top and lid. The knob is designed and is only available from TreCe. Head Ø30mm x Foot Ø12mm

Lid: Powder coated steel sheet

KLOSS M1 Square top in powder coated steel sheet 2 mm. Width 352 mm, Height 12 mm, Depth 352 mm.

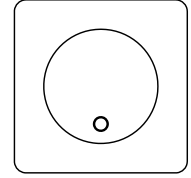
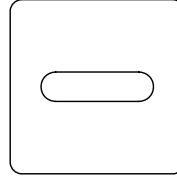
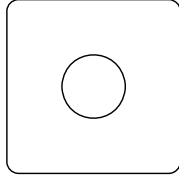
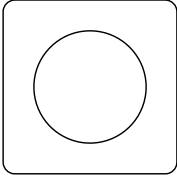

M1: Top

Hole Ø220 mm

Colour	Art no.
RAL 9010 White	32100101
RAL 7032 Warm Grey	32100120
RAL 7016 Anthracite	32100104
RAL 5023 Brilliant blue	32100121
RAL 1013 Pearl white	32100122
RAL 6013 Olive	32100123
RAL 6020 Forest green	32100124
RAL 8014 Chocolate	32100125
RAL 1017 Saffron	32100126
RAL 3014 Old pink	32100127
RAL 3005 Wine red	32100128

M1: Top

Hole Ø130 mm

Colour	Art no.
RAL 9010 White	32100201
RAL 7032 Warm Grey	32100220
RAL 7016 Anthracite	32100204
RAL 5023 Brilliant blue	32100221
RAL 1013 Pearl white	32100222
RAL 6013 Olive	32100223
RAL 6020 Forest green	32100224
RAL 8014 Chocolate	32100225
RAL 1017 Saffron	32100226
RAL 3014 Old pink	32100227
RAL 3005 Wine red	32100228

M1: Top

Oblong hole 60*230 mm

Colour	Art no.
RAL 9010 White	32100301
RAL 7032 Warm Grey	32100320
RAL 7016 Anthracite	32100304
RAL 5023 Brilliant blue	32100321
RAL 1013 Pearl white	32100322
RAL 6013 Olive	32100323
RAL 6020 Forest green	32100324
RAL 8014 Chocolate	32100325
RAL 1017 Saffron	32100326
RAL 3014 Old pink	32100327
RAL 3005 Wine red	32100328

M1: Top

Fixed lid with knob Ø235mm, hole Ø210mm

Colour	Art no.
RAL 9010 White	32100401
RAL 7032 Warm Grey	32100420
RAL 7016 Anthracite	32100404
RAL 5023 Brilliant blue	32100421
RAL 1013 Pearl white	32100422
RAL 6013 Olive	32100423
RAL 6020 Forest green	32100424
RAL 8014 Chocolate	32100425
RAL 1017 Saffron	32100426
RAL 3014 Old pink	32100427
RAL 3005 Wine red	32100428

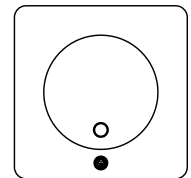
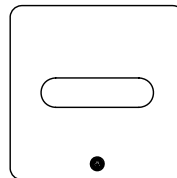
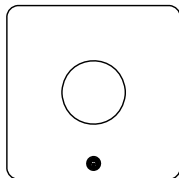
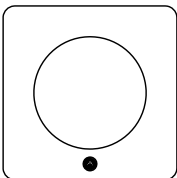

M1: Top with triangular lock

Hole Ø220 mm

Colour	Art no.
RAL 9010 White	32101101
RAL 7032 Warm Grey	32101120
RAL 7016 Anthracite	32101104
RAL 5023 Brilliant blue	32101121
RAL 1013 Pearl white	32101122
RAL 6013 Olive	32101123
RAL 6020 Forest green	32101124
RAL 8014 Chocolate	32101125
RAL 1017 Saffron	32101126
RAL 3014 Old pink	32101127
RAL 3005 Wine red	32101128

M1: Top with triangular lock

Hole Ø130 mm

Colour	Art no.
RAL 9010 White	32101201
RAL 7032 Warm Grey	32101220
RAL 7016 Anthracite	32101204
RAL 5023 Brilliant blue	32101221
RAL 1013 Pearl white	32101222
RAL 6013 Olive	32101223
RAL 6020 Forest green	32101224
RAL 8014 Chocolate	32101225
RAL 1017 Saffron	32101226
RAL 3014 Old pink	32101227
RAL 3005 Wine red	32101228

M1: Top with triangular lock

Oblong hole 60*230 mm

Colour	Art no.
RAL 9010 White	32101301
RAL 7032 Warm Grey	32101320
RAL 7016 Anthracite	32101304
RAL 5023 Brilliant blue	32101321
RAL 1013 Pearl white	32101322
RAL 6013 Olive	32101323
RAL 6020 Forest green	32101324
RAL 8014 Chocolate	32101325
RAL 1017 Saffron	32101326
RAL 3014 Old pink	32101327
RAL 3005 Wine red	32101328

M1: Top with triangular lock

Fixed lid with knob Ø235mm, hole Ø210mm

Colour	Art no.
RAL 9010 White	32101401
RAL 7032 Warm Grey	32101420
RAL 7016 Anthracite	32101404
RAL 5023 Brilliant blue	32101421
RAL 1013 Pearl white	32101422
RAL 6013 Olive	32101423
RAL 6020 Forest green	32101424
RAL 8014 Chocolate	32101425
RAL 1017 Saffron	32101426
RAL 3014 Old pink	32101427
RAL 3005 Wine red	32101428

Any RAL colour at an additional cost. Contact TreCe

Triangular key included when ordering top with lock. Can also be purchased separately.

Top: The Top is available in 4 variants with different external shapes, depending on the frame chosen. On the top of the fixed lid there is a knob in the same colour as the top and lid. The knob is designed and is only available from TreCe. Head Ø30mm x Foot Ø12mm

Lid: Powder coated steel sheet

KLOSS M2 Top in powder coated steel sheet 2 mm. Width 352 mm, Height 12 mm, Depth 352 mm.

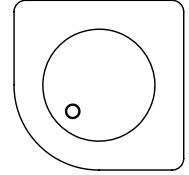
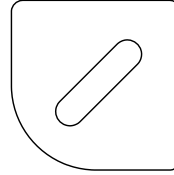
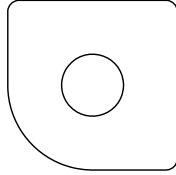
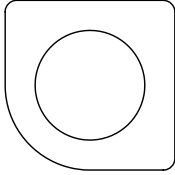

M2: Top

Hole Ø220 mm

Colour	Art no.
RAL 9010 White	32200101
RAL 7032 Warm Grey	32200120
RAL 7016 Anthracite	32200104
RAL 5023 Brilliant blue	32200121
RAL 1013 Pearl white	32200122
RAL 6013 Olive	32200123
RAL 6020 Forest green	32200124
RAL 8014 Chocolate	32200125
RAL 1017 Saffron	32200126
RAL 3014 Old pink	32200127
RAL 3005 Wine red	32200128

M2: Top

Hole Ø130 mm

Colour	Art no.
RAL 9010 White	32200201
RAL 7032 Warm Grey	32200220
RAL 7016 Anthracite	32200204
RAL 5023 Brilliant blue	32200221
RAL 1013 Pearl white	32200222
RAL 6013 Olive	32200223
RAL 6020 Forest green	32200224
RAL 8014 Chocolate	32200225
RAL 1017 Saffron	32200226
RAL 3014 Old pink	32200227
RAL 3005 Wine red	32200228

M2: Top

Oblong hole 60*230 mm

Colour	Art no.
RAL 9010 White	32200301
RAL 7032 Warm Grey	32200320
RAL 7016 Anthracite	32200304
RAL 5023 Brilliant blue	32200321
RAL 1013 Pearl white	32200322
RAL 6013 Olive	32200323
RAL 6020 Forest green	32200324
RAL 8014 Chocolate	32200325
RAL 1017 Saffron	32200326
RAL 3014 Old pink	32200327
RAL 3005 Wine red	32200328

M2: Top

Fixed lid with knob Ø235mm, hole Ø210mm

Colour	Art no.
RAL 9010 White	32200401
RAL 7032 Warm Grey	32200420
RAL 7016 Anthracite	32200404
RAL 5023 Brilliant blue	32200421
RAL 1013 Pearl white	32200422
RAL 6013 Olive	32200423
RAL 6020 Forest green	32200424
RAL 8014 Chocolate	32200425
RAL 1017 Saffron	32200426
RAL 3014 Old pink	32200427
RAL 3005 Wine red	32200428

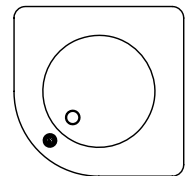
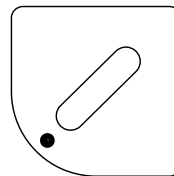
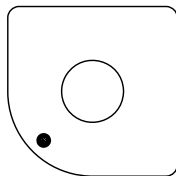
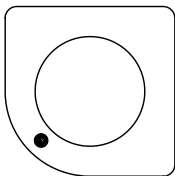

M2: Top with triangular lock

Hole Ø220 mm

Colour	Art no.
RAL 9010 White	32201101
RAL 7032 Warm Grey	32201120
RAL 7016 Anthracite	32201104
RAL 5023 Brilliant blue	32201121
RAL 1013 Pearl white	32201122
RAL 6013 Olive	32201123
RAL 6020 Forest green	32201124
RAL 8014 Chocolate	32201125
RAL 1017 Saffron	32201126
RAL 3014 Old pink	32201127
RAL 3005 Wine red	32201128

M2: Top with triangular lock

Hole Ø130 mm

Colour	Art no.
RAL 9010 White	32201201
RAL 7032 Warm Grey	32201220
RAL 7016 Anthracite	32201204
RAL 5023 Brilliant blue	32201221
RAL 1013 Pearl white	32201222
RAL 6013 Olive	32201223
RAL 6020 Forest green	32201224
RAL 8014 Chocolate	32201225
RAL 1017 Saffron	32201226
RAL 3014 Old pink	32201227
RAL 3005 Wine red	32201228

M2: Top with triangular lock

Oblong hole 60*230 mm

Colour	Art no.
RAL 9010 White	32201301
RAL 7032 Warm Grey	32201320
RAL 7016 Anthracite	32201304
RAL 5023 Brilliant blue	32201321
RAL 1013 Pearl white	32201322
RAL 6013 Olive	32201323
RAL 6020 Forest green	32201324
RAL 8014 Chocolate	32201325
RAL 1017 Saffron	32201326
RAL 3014 Old pink	32201327
RAL 3005 Wine red	32201328

M2: Top with triangular lock

Fixed lid with knob Ø235mm, hole Ø210mm

Colour	Art no.
RAL 9010 White	32201401
RAL 7032 Warm Grey	32201420
RAL 7016 Anthracite	32201404
RAL 5023 Brilliant blue	32201421
RAL 1013 Pearl white	32201422
RAL 6013 Olive	32201423
RAL 6020 Forest green	32201424
RAL 8014 Chocolate	32201425
RAL 1017 Saffron	32201426
RAL 3014 Old pink	32201427
RAL 3005 Wine red	32201428

Any RAL colour at an additional cost. Contact TreCe

Triangular key included when ordering top with lock. Can also be purchased separately.

Top: The Top is available in 4 variants with different external shapes, depending on the frame chosen. On the top of the fixed lid there is a knob in the same colour as the top and lid. The knob is designed and is only available from TreCe. Head Ø30mm x Foot Ø12mm

Lid: Powder coated steel sheet

KLOSS M3 Top in powder coated steel sheet 2 mm. Width 352 mm, Height 12 mm, Depth 352 mm.

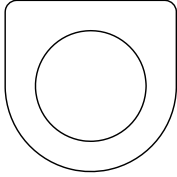

M3: Top

Hole Ø220 mm

Colour	Art no.
RAL 9010 White	32300101
RAL 7032 Warm Grey	32300120
RAL 7016 Anthracite	32300104
RAL 5023 Brilliant blue	32300121
RAL 1013 Pearl white	32300122
RAL 6013 Olive	32300123
RAL 6020 Forest green	32300124
RAL 8014 Chocolate	32300125
RAL 1017 Saffron	32300126
RAL 3014 Old pink	32300127
RAL 3005 Wine red	32300128

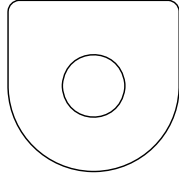

M3: Top

Hole Ø130 mm

Colour	Art no.
RAL 9010 White	32300201
RAL 7032 Warm Grey	32300220
RAL 7016 Anthracite	32300204
RAL 5023 Brilliant blue	32300221
RAL 1013 Pearl white	32300222
RAL 6013 Olive	32300223
RAL 6020 Forest green	32300224
RAL 8014 Chocolate	32300225
RAL 1017 Saffron	32300226
RAL 3014 Old pink	32300227
RAL 3005 Wine red	32300228

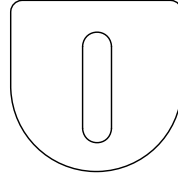

M3: Top

Oblong hole 60*230 mm

Colour	Art no.
RAL 9010 White	32300301
RAL 7032 Warm Grey	32300320
RAL 7016 Anthracite	32300304
RAL 5023 Brilliant blue	32300321
RAL 1013 Pearl white	32300322
RAL 6013 Olive	32300323
RAL 6020 Forest green	32300324
RAL 8014 Chocolate	32300325
RAL 1017 Saffron	32300326
RAL 3014 Old pink	32300327
RAL 3005 Wine red	32300328

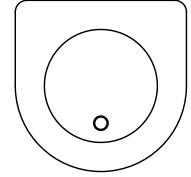

M3: Top

Fixed lid with knob Ø235mm, hole Ø210mm

Colour	Art no.
RAL 9010 White	32300401
RAL 7032 Warm Grey	32300420
RAL 7016 Anthracite	32300404
RAL 5023 Brilliant blue	32300421
RAL 1013 Pearl white	32300422
RAL 6013 Olive	32300423
RAL 6020 Forest green	32300424
RAL 8014 Chocolate	32300425
RAL 1017 Saffron	32300426
RAL 3014 Old pink	32300427
RAL 3005 Wine red	32300428

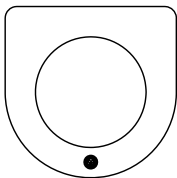

M3: Top with triangular lock

Hole Ø220 mm

Colour	Art no.
RAL 9010 White	32301101
RAL 7032 Warm Grey	32301120
RAL 7016 Anthracite	32301104
RAL 5023 Brilliant blue	32301121
RAL 1013 Pearl white	32301122
RAL 6013 Olive	32301123
RAL 6020 Forest green	32301124
RAL 8014 Chocolate	32301125
RAL 1017 Saffron	32301126
RAL 3014 Old pink	32301127
RAL 3005 Wine red	32301128

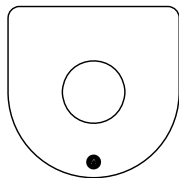

M3: Top with triangular lock

Hole Ø130 mm

Colour	Art no.
RAL 9010 White	32301201
RAL 7032 Warm Grey	32301220
RAL 7016 Anthracite	32301204
RAL 5023 Brilliant blue	32301221
RAL 1013 Pearl white	32301222
RAL 6013 Olive	32301223
RAL 6020 Forest green	32301224
RAL 8014 Chocolate	32301225
RAL 1017 Saffron	32301226
RAL 3014 Old pink	32301227
RAL 3005 Wine red	32301228

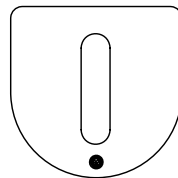

M3: Top with triangular lock

Oblong hole 60*230 mm

Colour	Art no.
RAL 9010 White	32301301
RAL 7032 Warm Grey	32301320
RAL 7016 Anthracite	32301304
RAL 5023 Brilliant blue	32301321
RAL 1013 Pearl white	32301322
RAL 6013 Olive	32301323
RAL 6020 Forest green	32301324
RAL 8014 Chocolate	32301325
RAL 1017 Saffron	32301326
RAL 3014 Old pink	32301327
RAL 3005 Wine red	32301328

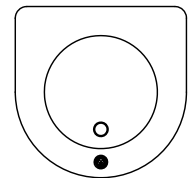

M3: Top with triangular lock

Fixed lid with knob Ø235mm, hole Ø210mm

Colour	Art no.
RAL 9010 White	32301401
RAL 7032 Warm Grey	32301420
RAL 7016 Anthracite	32301404
RAL 5023 Brilliant blue	32301421
RAL 1013 Pearl white	32301422
RAL 6013 Olive	32301423
RAL 6020 Forest green	32301424
RAL 8014 Chocolate	32301425
RAL 1017 Saffron	32301426
RAL 3014 Old pink	32301427
RAL 3005 Wine red	32301428

Any RAL colour at an additional cost. Contact TreCe

Triangular key included when ordering top with lock. Can also be purchased separately.

Top: The compact laminate top is available in 3 different versions depending on the frame chosen.

Lid: Lid in compact laminate with knob powder coated RAL according to the table below. The knob is designed and only available at TreCe.

Head Ø30mm x Foot Ø12 mm

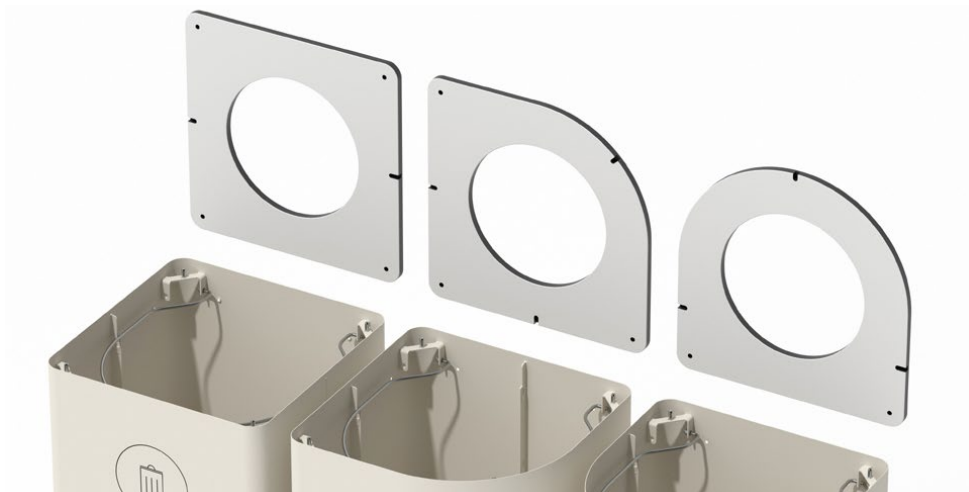

KLOSS Top Compact laminate with black core, H352 x D12 x W352

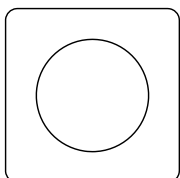

M1: Top compact laminate

Hole Ø220 mm

Colour	Colour	Art no.
F2297 Terril	Anthracite	32100161
F2255 Polar White	White	32100162
F5343 Possum	Olive grey	32100163

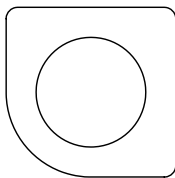

M2: Top compact laminate

Hole Ø220 mm

Colour	Colour	Art no.
F2297 Terril	Anthracite	32200161
F2255 Polar White	White	32200162
F5343 Possum	Olive grey	32200163

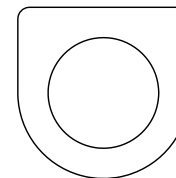

M2: Top compact laminate

Hole Ø220 mm

Colour	Colour	Art no.
F2297 Terril	Anthracite	32300161
F2255 Polar White	White	32300162
F5343 Possum	Olive grey	32300163

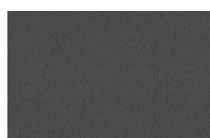

Anthracite (F2297)

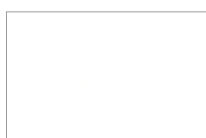

White (F2255)



Olive grey (F5343)

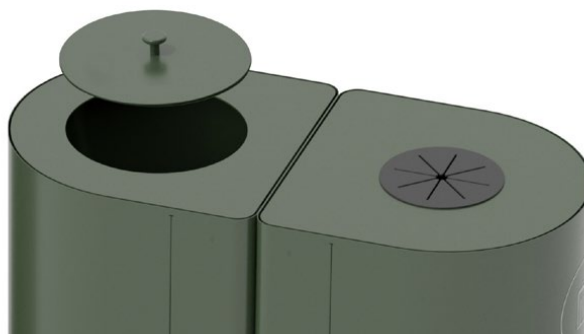

*The rubber insert fits in tops that have a Ø130 hole. It is removable for cleaning and reversible.

KLOSS Lock Compact laminate with black core

Including KLOSS knob

Hole Ø220 mm

Colour	Colour	Knob/Colour	Art no.
F2297 Terril	Anthracite	RAL 7016	32700261
F2255 Polar White	White	RAL 9010	32700262
F5343 Possum	Olive grey	RAL 6013	32700263



Wall mount: Powder coated steel sheet

KLOSS Symbol Ø120 mm, white or anthracite (factory mounted on the front frame)

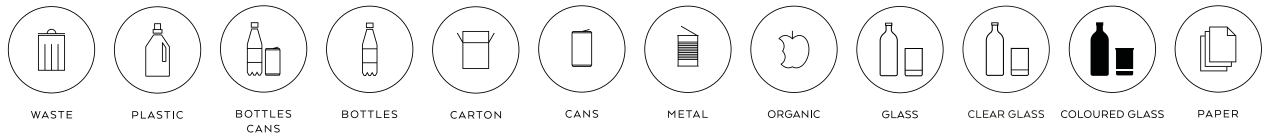

Colour	Art no.											
White	32900101	32900201	32900301	32900401	32900501	32900601	32900701	32901001	32901301	32901101	32901201	32900901
Anthracite	32900104	32900204	32900304	32900404	32900504	32900604	32900704	32901004	32901304	32901104	32901204	32900904

See page 4 for reference



KLOSS Wall bracket Powder coated steel sheet



Wall bracket 1 frame

W:276 mm, D:18 mm, H:702 mm

Colour	Art no.
RAL 9010 White	32703101
RAL 7032 Warm Grey	32703120
RAL 7016 Anthracite	32703104
RAL 5023 Brilliant blue	32703121
RAL 1013 Pearl white	32703122
RAL 6013 Olive	32703123
RAL 6020 Forest green	32703124
RAL 8014 Chocolate	32703125
RAL 1017 Saffron	32703126
RAL 3014 Old pink	32703127
RAL 3005 Wine red	32703128



Wall bracket 2 frame

W:637 mm, D:18 mm, H:702 mm

Colour	Art no.
RAL 9010 White	32703201
RAL 7032 Warm Grey	32703220
RAL 7016 Anthracite	32703204
RAL 5023 Brilliant blue	32703221
RAL 1013 Pearl white	32703222
RAL 6013 Olive	32703223
RAL 6020 Forest green	32703224
RAL 8014 Chocolate	32703225
RAL 1017 Saffron	32703226
RAL 3014 Old pink	32703227
RAL 3005 Wine red	32703228

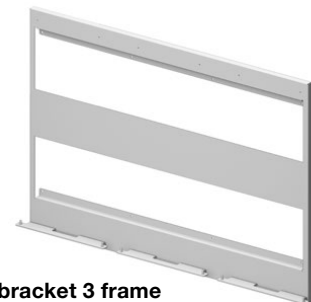

Wall bracket 3 frame

W:998 mm, D:18 mm, H:702 mm

Colour	Art no.
RAL 9010 White	32703301
RAL 7032 Warm Grey	32703320
RAL 7016 Anthracite	32703304
RAL 5023 Brilliant blue	32703321
RAL 1013 Pearl white	32703322
RAL 6013 Olive	32703323
RAL 6020 Forest green	32703324
RAL 8014 Chocolate	32703325
RAL 1017 Saffron	32703326
RAL 3014 Old pink	32703327
RAL 3005 Wine red	32703328

Contact TreCe if more than 3 KLOSS are to be mounted next to each other, spacer template available.

Any RAL colour for an additional charge, contact TreCe.

Leg: Powder coated steel sheet

Wheels: Black plain bearing wheels with nylon rim and rubber track. Black lacquered bracket



Powder coated adjustable legs.



Wheels, with or without brakes.



Without legs or wheels, small adjustable feet are included.

KLOSS Leg

The legs is designed and only available at TreCe. Powder coated in our standard colours.



Powder coated leg, adjustable

Art.no. for KLOSS leg refers to 1 piece, adapt the number based on your complete set-up.

Dimensions: Ø48 x H85mm

Colour	Art no.
RAL 9010 White	32703001
RAL 7032 Warm Grey	32703020
RAL 7016 Anthracite	32703004
RAL 5023 Brilliant blue	32703021
RAL 1013 Pearl white	32703022
RAL 6013 Olive	32703023
RAL 6020 Forest green	32703024
RAL 8014 Chocolate	32703025
RAL 1017 Saffron	32703026
RAL 3014 Old pink	32703027
RAL 3005 Wine red	32703028

KLOSS Wheel

Art.no. for KLOSS wheel refers to 1 piece, adapt the number based on your complete set-up. Black plain bearing wheel with nylon rim and rubber track. Black lacquered bracket.



Wheel with and without brakes

Dimensions: Ø50 x H19mm

Name	Description	Colour	Art no.
KLOSS Wheel	Without brake Load capacity 50 kg	Black	32705303
KLOSS Wheel	With brake Load capacity 50 kg Use 2 per setup	Black	32705403

KLOSS Overview of placement of wheels & legs

The overview below shows the recommended number of wheels or legs per set-up. Both wheels and legs are sold individually. When ordering wheels, choose 2 of the wheels with brakes.

Singular basic units

Placement of legs or wheels



Selection of standard set-ups

Placements of legs or wheels (units on wheels are coupled)

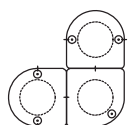
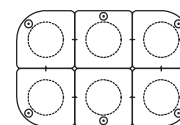
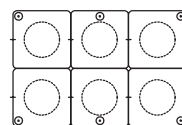
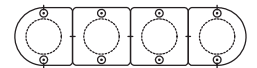
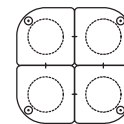
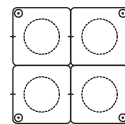
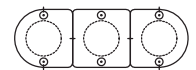
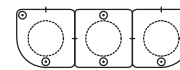
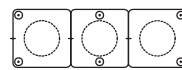
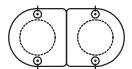
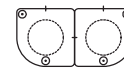
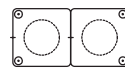

Container & Base insert: 100% recycled ABS plastic
Rubber insert: Black ECO EPDM rubber.

Accessories: Fits all modules

Product	Description	Size	Colour	Art no.
Container	Approx. 45L. Handle W80 x H30mm. Recycled ABS plastic 3 mm.	Ø320 x H650	Grey	32705003
Base insert	Insert with perforated grid Recycled ABS plastic 3 mm.	Ø240 x H100	Grey	32705103
Triangular key	Extra key for tops with lock.	W50 x H80	Silver	32705203
Garbage bag	85 L, 25 pcs/roll		Black	321699
Rubber insert	Reversible Glass/PET insert for KLOSS tops with Ø130 holes. Black ECO EPDM rubber.	Ø150	Black	321610

Container 45 L and base insert.

Base insert is used as bottom insert in the container. The perforated grid is anchored to ventilate moisture.

Add the base insert when using food waste bags as they often have a lower depth.

Stackable container with handle.



Accessories: Decal sheet

KLOSS decal sheet - Symbol Ø40 x H55mm (height of the whole decal)
 Order if you want to add a symbol on the top/lid.

Description	Unit	Colour	Art no.
Decal sheet recycling - English text			
English, white text	21 pcs/ set	White	32706101
English, anthracite text	21 pcs/ set	Anthracite	32706104
Decal sheet recycling - Swedish text			
Swedish, white text	21 pcs/ set	White	32706201
Swedish, anthracite text	21 pcs/ set	Anthracite	32706204
Decal sheet recycling - Norwegian text			
Norwegian, white text	18 pcs/ set	White	32706301
Norwegian, anthracite text	18 pcs/ set	Anthracite	32706304

Please contact TreCe if you want other symbols or text in other languages.



KLOSS Small

Design | **Kauppi & Kauppi**

NEW
2024



KLOSS Small Old pink RAL 3014 och Pearl white RAL 1013 with leg stands

The KLOSS recycling system is expanding with two new smaller module sizes and several new features - transitioning from being a modular collection to a larger recycling furniture infrastructure. The new additions, KLOSS Small and KLOSS Mini, enable waste sorting everywhere - from large spaces and interiors to smaller and closer situations. The smaller KLOSS sizes fit well in any context where sorting modules are needed, even in spaces where it may be limited or where the bins need to harmonize with the overall interior style. Depending on the choice of size, composition, color, and accessories, KLOSS can either blend in or characterize a space.

KLOSS Small works well next to work desks, by or under tables, on walls, and between furniture. A completely new accessory for the KLOSS system is the leg stand, designed to group and elevate small friendly sorting stations without heavy shading. Suitable as standalone islands in corridors or as small recycling units next to sofas, chairs, and benches in seating areas. KLOSS Small can either be wall-mounted individually or placed in rows on narrow steel frames, reflecting the options available for the larger KLOSS trash bins as well.



KLOSS Small Pearl white RAL 1013 with leg stand



KLOSS Small Pearl white RAL 1013 with wall bracket



Frame/Top/Wall bracket/Knob/Leg/Leg stand: Powder coated steel sheet

Lid: Powder coated steel sheet and compact laminate

Container & Base insert: 100% recycled ABS plastic

Rubber insert: Black ECO EPDM rubber

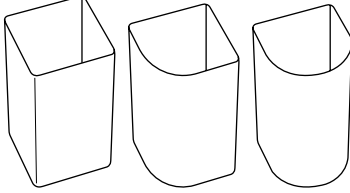
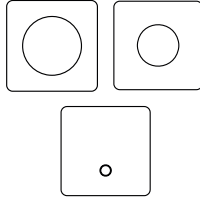
How to order KLOSS small:

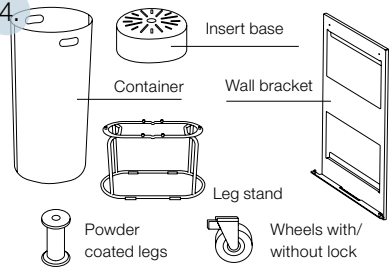
<p>1.</p> 	<p>2.</p> 	<p>3.</p> 	<p>4.</p> 
<p>Choose frame and colour Bin with adjustable feet. Integrated bag holder included.</p>	<p>Choose top and colour Soft closing fixed in powder-coated steel sheet.</p>	<p>Choose symbol Order more symbols per unit, if the product is to be placed on a standalone basis</p>	<p>Choose accessories: legs or wheels, wall bracket, lid, container and base insert. Integrated bag holder included in all models.</p>

KLOSS small Frame in powder coated steel sheet 1 mm. Width 280 mm, Height 450 mm, Depth 280 mm.

Markings on the illustrations refer to the visible mounting lines of the connection holes.

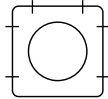

M1 Small: Square frame

Holds approx. 35 L

Colour	Art no.
RAL 9010 White	32110001
RAL 7032 Warm Grey	32110020
RAL 7016 Anthracite	32110004
RAL 5023 Brilliant blue	32110021
RAL 1013 Pearl white	32110022
RAL 6013 Olive	32110023
RAL 6020 Forest green	32110024
RAL 8014 Chocolate	32110025
RAL 1017 Saffron	32110026
RAL 3014 Old pink	32110027
RAL 3005 Wine red	32110028

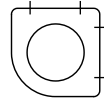

M2 Small: Frame with one round corner

Holds approx. 33 L

Colour	Art no.
RAL 9010 White	32210001
RAL 7032 Warm Grey	32210020
RAL 7016 Anthracite	32210004
RAL 5023 Brilliant blue	32210021
RAL 1013 Pearl white	32210022
RAL 6013 Olive	32210023
RAL 6020 Forest green	32210024
RAL 8014 Chocolate	32210025
RAL 1017 Saffron	32210026
RAL 3014 Old pink	32210027
RAL 3005 Wine red	32210028

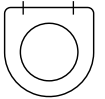

M3 Small: Frame with a straight side and rounded front

Holds approx. 32 L

Colour	Art no.
RAL 9010 White	32310001
RAL 7032 Warm Grey	32310020
RAL 7016 Anthracite	32310004
RAL 5023 Brilliant blue	32310021
RAL 1013 Pearl white	32310022
RAL 6013 Olive	32310023
RAL 6020 Forest green	32310024
RAL 8014 Chocolate	32310025
RAL 1017 Saffron	32310026
RAL 3014 Old pink	32310027
RAL 3005 Wine red	32310028

Any RAL colour at an additional cost, contact TreCe.

KLOSS Small Colours



White Warm Grey Anthracite Brilliant blue Pearl white Olive Forest green Chocolate Saffron Old pink Wine red

Top: The Top is available in 4 variants with different external shapes, depending on the frame chosen. On the top of the fixed lid there is a knob in the same colour as the top and lid. The knob is designed and is only available from TreCe. Head Ø30mm x Foot Ø12mm

Lid: Powder coated steel sheet

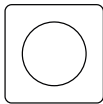
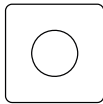
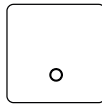

KLOSS SMALL M1 Damped square top in powder coated steel sheet, 1.5 mm. Width 273 mm, Depth 273 mm.

 M1 Small: Top Hole Ø180 mm		 M1 Small: Top Hole Ø130 mm		 M1 Small: Top Full cover top with knob	
Colour	Art no.	Colour	Art no.	Colour	Art no.
RAL 9010 White	32110101	RAL 9010 White	32110201	RAL 9010 White	32112101
RAL 7032 Warm Grey	32110120	RAL 7032 Warm Grey	32110220	RAL 7032 Warm Grey	32112120
RAL 7016 Anthracite	32110104	RAL 7016 Anthracite	32110204	RAL 7016 Anthracite	32112104
RAL 5023 Brilliant blue	32110121	RAL 5023 Brilliant blue	32110221	RAL 5023 Brilliant blue	32112121
RAL 1013 Pearl white	32110122	RAL 1013 Pearl white	32110222	RAL 1013 Pearl white	32112122
RAL 6013 Olive	32110123	RAL 6013 Olive	32110223	RAL 6013 Olive	32112123
RAL 6020 Forest green	32110124	RAL 6020 Forest green	32110224	RAL 6020 Forest green	32112124
RAL 8014 Chocolate	32110125	RAL 8014 Chocolate	32110225	RAL 8014 Chocolate	32112125
RAL 1017 Saffron	32110126	RAL 1017 Saffron	32110226	RAL 1017 Saffron	32112126
RAL 3014 Old pink	32110127	RAL 3014 Old pink	32110227	RAL 3014 Old pink	32112127
RAL 3005 Wine red	32110128	RAL 3005 Wine red	32110228	RAL 3005 Wine red	32112128

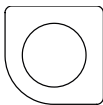
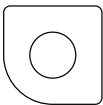
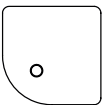
KLOSS SMALL M2 Damped top in powder coated steel sheet, 1.5 mm. Width 273 mm, Depth 273 mm.

 M2 Small: Top Hole Ø180 mm		 M2 Small: Top Hole Ø130 mm		 M2 Small: Top Full cover top with knob	
Colour	Art no.	Colour	Art no.	Colour	Art no.
RAL 9010 White	32210101	RAL 9010 White	32210201	RAL 9010 White	32212101
RAL 7032 Warm Grey	32210120	RAL 7032 Warm Grey	32210220	RAL 7032 Warm Grey	32212120
RAL 7016 Anthracite	32210104	RAL 7016 Anthracite	32210204	RAL 7016 Anthracite	32212104
RAL 5023 Brilliant blue	32210121	RAL 5023 Brilliant blue	32210221	RAL 5023 Brilliant blue	32212121
RAL 1013 Pearl white	32210122	RAL 1013 Pearl white	32210222	RAL 1013 Pearl white	32212122
RAL 6013 Olive	32210123	RAL 6013 Olive	32210223	RAL 6013 Olive	32212123
RAL 6020 Forest green	32210124	RAL 6020 Forest green	32210224	RAL 6020 Forest green	32212124
RAL 8014 Chocolate	32210125	RAL 8014 Chocolate	32210225	RAL 8014 Chocolate	32212125
RAL 1017 Saffron	32210126	RAL 1017 Saffron	32210226	RAL 1017 Saffron	32212126
RAL 3014 Old pink	32210127	RAL 3014 Old pink	32210227	RAL 3014 Old pink	32212127
RAL 3005 Wine red	32210128	RAL 3005 Wine red	32210228	RAL 3005 Wine red	32212128

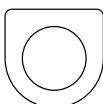
KLOSS SMALL M3 Damped top in powder coated steel sheet, 1.5 mm. Width 273 mm, Depth 273 mm.

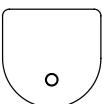
 M3 Small: Top Hole Ø180 mm		 M3 Small: Top Hole Ø130 mm		 M3 Small: Top Full cover top with knob	
Colour	Art no.	Colour	Art no.	Colour	Art no.
RAL 9010 White	32310101	RAL 9010 White	32310201	RAL 9010 White	32312101
RAL 7032 Warm Grey	32310120	RAL 7032 Warm Grey	32310220	RAL 7032 Warm Grey	32312120
RAL 7016 Anthracite	32310104	RAL 7016 Anthracite	32310204	RAL 7016 Anthracite	32312104
RAL 5023 Brilliant blue	32310121	RAL 5023 Brilliant blue	32310221	RAL 5023 Brilliant blue	32312121
RAL 1013 Pearl white	32310122	RAL 1013 Pearl white	32310222	RAL 1013 Pearl white	32312122
RAL 6013 Olive	32310123	RAL 6013 Olive	32310223	RAL 6013 Olive	32312123
RAL 6020 Forest green	32310124	RAL 6020 Forest green	32310224	RAL 6020 Forest green	32312124
RAL 8014 Chocolate	32310125	RAL 8014 Chocolate	32310225	RAL 8014 Chocolate	32312125
RAL 1017 Saffron	32310126	RAL 1017 Saffron	32310226	RAL 1017 Saffron	32312126
RAL 3014 Old pink	32310127	RAL 3014 Old pink	32310227	RAL 3014 Old pink	32312127
RAL 3005 Wine red	32310128	RAL 3005 Wine red	32310228	RAL 3005 Wine red	32312128

Any RAL colour at an additional cost. Contact TreCe

Wall mount: Powder coated steel sheet

KLOSS Small Symbol Ø100 mm, white or anthracite (factory mounted on the front frame)

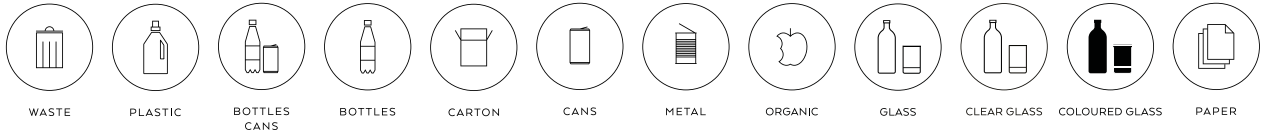

Colour	Art no.											
White	32910101	32910201	32910301	32910401	32910501	32910601	32910701	32911001	32911301	32911101	32911201	32910901
Anthracite	32910104	32910204	32910304	32910404	32910504	32910604	32910704	32911004	32911304	32911104	32911204	32910904

See page 4 for reference



KLOSS Mini with wall bracket Forest green RAL 6020, **KLOSS Small with wall bracket** Pearl white RAL 1013, **KLOSS with wall bracket** Olive RAL 6013

KLOSS Wall bracket, Small Powder coated steel sheet



Wall bracket Small 1 frame

W:242 mm, H:432 mm, D:28 mm

Colour	Art no.
RAL 9010 White	32713101
RAL 7032 Warm Grey	32713120
RAL 7016 Anthracite	32713104
RAL 5023 Brilliant blue	32713121
RAL 1013 Pearl white	32713122
RAL 6013 Olive	32713123
RAL 6020 Forest green	32713124
RAL 8014 Chocolate	32713125
RAL 1017 Saffron	32713126
RAL 3014 Old pink	32713127
RAL 3005 Wine red	32713128

Wall bracket Small 2 frame

W:523 mm, H:432 mm, D:28 mm

Colour	Art no.
RAL 9010 White	32713201
RAL 7032 Warm Grey	32713220
RAL 7016 Anthracite	32713204
RAL 5023 Brilliant blue	32713221
RAL 1013 Pearl white	32713222
RAL 6013 Olive	32713223
RAL 6020 Forest green	32713224
RAL 8014 Chocolate	32713225
RAL 1017 Saffron	32713226
RAL 3014 Old pink	32713227
RAL 3005 Wine red	32713228

Wall bracket Small 3 frame

W:803 mm, H:432 mm, D:28 mm

Colour	Art no.
RAL 9010 White	32713301
RAL 7032 Warm Grey	32713320
RAL 7016 Anthracite	32713304
RAL 5023 Brilliant blue	32713321
RAL 1013 Pearl white	32713322
RAL 6013 Olive	32713323
RAL 6020 Forest green	32713324
RAL 8014 Chocolate	32713325
RAL 1017 Saffron	32713326
RAL 3014 Old pink	32713327
RAL 3005 Wine red	32713328

Wall bracket Small 4 frame

W:1083 mm, H:432 mm, D:28 mm

Colour	Art no.
RAL 9010 White	32713401
RAL 7032 Warm Grey	32713420
RAL 7016 Anthracite	32713404
RAL 5023 Brilliant blue	32713421
RAL 1013 Pearl white	32713422
RAL 6013 Olive	32713423
RAL 6020 Forest green	32713424
RAL 8014 Chocolate	32713425
RAL 1017 Saffron	32713426
RAL 3014 Old pink	32713427
RAL 3005 Wine red	32713428

Leg stand: Powder coated steel sheet



KLOSS Small Old pink RAL 3014 och Pearl white RAL 1013 with leg stand



KLOSS Small Pearl white RAL 1013 with leg stand

KLOSS Small leg stand Powder coated steel wire Ø12 mm

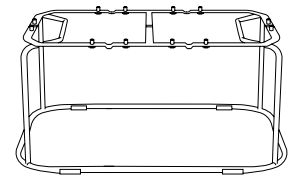
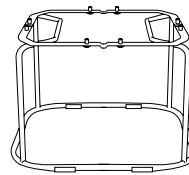
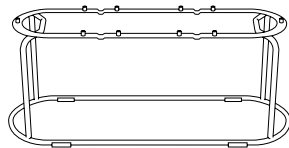
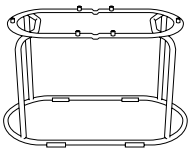

KLOSS Small Leg stand 2

W:560 mm, H:254 mm, D:280 mm

Fits 2 interconnected
KLOSS Small

Colour	Art no.
RAL 9010 White	32714101
RAL 7032 Warm Grey	32714120
RAL 7016 Anthracite	32714104
RAL 5023 Brilliant blue	32714121
RAL 1013 Pearl white	32714122
RAL 6013 Olive	32714123
RAL 6020 Forest green	32714124
RAL 8014 Chocolate	32714125
RAL 1017 Saffron	32714126
RAL 3014 Old pink	32714127
RAL 3005 Wine red	32714128

KLOSS Small Leg stand 3

W:840 mm, H:254 mm, D:280 mm

Fits 3 interconnected
KLOSS Small

Colour	Art no.
RAL 9010 White	32714201
RAL 7032 Warm Grey	32714220
RAL 7016 Anthracite	32714204
RAL 5023 Brilliant blue	32714221
RAL 1013 Pearl white	32714222
RAL 6013 Olive	32714223
RAL 6020 Forest green	32714224
RAL 8014 Chocolate	32714225
RAL 1017 Saffron	32714226
RAL 3014 Old pink	32714227
RAL 3005 Wine red	32714228

KLOSS Small Leg stand 4

W:560 mm, H:254 mm, D:560 mm

Fits 4 interconnected
KLOSS Small

Colour	Art no.
RAL 9010 White	32714301
RAL 7032 Warm Grey	32714320
RAL 7016 Anthracite	32714304
RAL 5023 Brilliant blue	32714321
RAL 1013 Pearl white	32714322
RAL 6013 Olive	32714323
RAL 6020 Forest green	32714324
RAL 8014 Chocolate	32714325
RAL 1017 Saffron	32714326
RAL 3014 Old pink	32714327
RAL 3005 Wine red	32714328

KLOSS Small Leg stand 6

W:840 mm, H:254 mm, D:560 mm

Fits 6 interconnected
KLOSS Small

Colour	Art no.
RAL 9010 White	32714401
RAL 7032 Warm Grey	32714420
RAL 7016 Anthracite	32714404
RAL 5023 Brilliant blue	32714421
RAL 1013 Pearl white	32714422
RAL 6013 Olive	32714423
RAL 6020 Forest green	32714424
RAL 8014 Chocolate	32714425
RAL 1017 Saffron	32714426
RAL 3014 Old pink	32714427
RAL 3005 Wine red	32714428

Any RAL colour at an additional cost. Contact TreCe

Leg: Powder coated steel sheet

Wheels: Black plain bearing wheels with nylon rim and rubber track. Black lacquered bracket

Container & Base insert: 100% recycled ABS plastic

Rubber insert: Black ECO EPDM rubber.

KLOSS Leg

The leg is designed and only available at TreCe.
Powder coated in our standard colours.

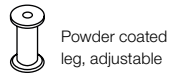

Powder coated leg, adjustable

Art.no. for KLOSS leg refers to 1 piece, adapt the number based on your complete set-up.

Dimensions: Ø48 x H85mm

Colour	Art no.
RAL 9010 White	32703001
RAL 7032 Warm Grey	32703020
RAL 7016 Anthracite	32703004
RAL 5023 Brilliant blue	32703021
RAL 1013 Pearl white	32703022
RAL 6013 Olive	32703023
RAL 6020 Forest green	32703024
RAL 8014 Chocolate	32703025
RAL 1017 Saffron	32703026
RAL 3014 Old pink	32703027
RAL 3005 Wine red	32703028

KLOSS Wheel

Art.no. for KLOSS wheel refers to 1 piece, adapt the number based on your complete set-up.

Black plain bearing wheel with nylon rim and rubber track. Black lacquered bracket.



Wheel with and without brakes

Dimensions: Ø50 x H19mm

Name	Description	Colour	Art no.
KLOSS Wheel	Without brake Load capacity 50 kg	Black	32705303
KLOSS Wheel	With brake Load capacity 50 kg Use 2 per setup	Black	32705403

Accessories: Fits all modules KLOSS Small

Rubber insert, legs and wheels are also available as accessories for Small and Mini.

Product	Description	Size	Colour	Art no.
Container Small	Approx. 18 L. Recycled ABS plastic 3 mm.	Ø246 x H417	Grey	32715003
Base insert Small	Insert with perforated grid Recycled ABS plastic 3 mm.	Ø185 x H60	Grey	32715103
Rubber insert	Reversible Glass/PET insert for KLOSS tops with Ø130 holes. Black ECO EPDM rubber.	Ø150	Black	32705203



KLOSS Overview of placement of wheels & legs

The overview below shows the recommended number of wheels or legs per set-up. Both wheels and legs are sold individually.
When ordering wheels, choose 2 of the wheels with brakes.

Singular basic units

Placement of legs or wheels

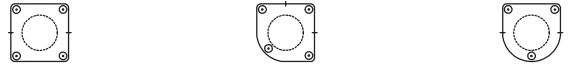

Selection of standard set-ups

Placements of legs or wheels (units on wheels are coupled)

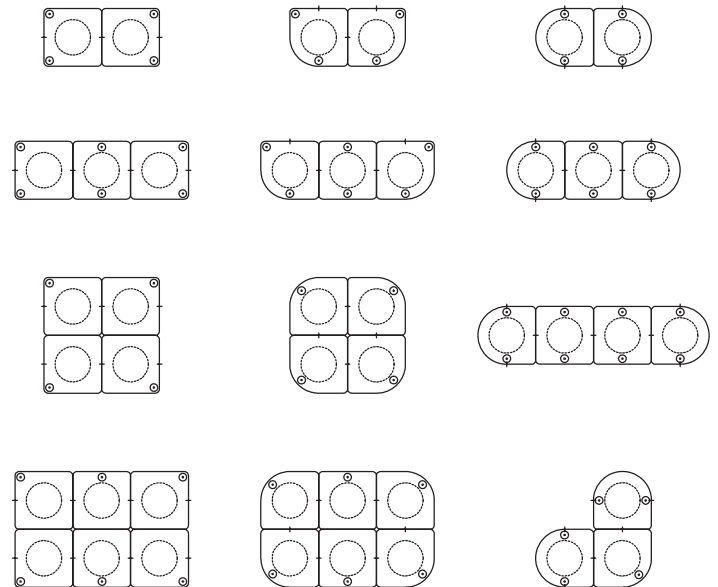

Accessories: Decal sheet

KLOSS decal sheet - Symbol Ø40 x H55mm (height of the whole decal)
Order if you want to add a symbol on the top/lid.

Description	Unit	Colour	Art no.
Decal sheet recycling - English text			
English, white text	21 pcs/ set	White	32706101
English, anthracite text	21 pcs/ set	Anthracite	32706104
Decal sheet recycling - Swedish text			
Swedish, white text	21 pcs/ set	White	32706201
Swedish, anthracite text	21 pcs/ set	Anthracite	32706204
Decal sheet recycling - Norwegian text			
Norwegian, white text	18 pcs/ set	White	32706301
Norwegian, anthracite text	18 pcs/ set	Anthracite	32706304

Examples of decals:

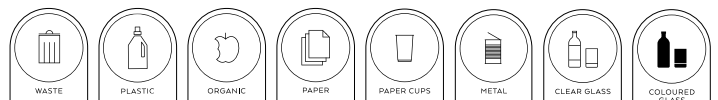

Please contact TreCe if you want other symbols or text in other languages.



The KLOSS waste separation system grows with two new smaller module sizes and several new features - elevating itself from a modular collection to a larger recycling furniture infrastructure. The new additions KLOSS Small and KLOSS Mini enable waste separation everywhere - from large spaces and interiors to smaller and closer situations. The smaller KLOSS sizes fit well into any context where sorting modules are needed, even where space may be limited or where the bins need to harmonise with the overall interior style. KLOSS can blend in or characterise a space depending on the choice of size, composition, colour and accessories.

KLOSS Mini fits well next to desks, at or under tables, on walls and between furniture. A brand new accessory to the KLOSS system is the leg stand, designed to group and elevate small friendly sorting stations without heavy shading. Suitable as standalone islands in corridors or as small recycling units next to sofas, armchairs and benches in seating areas. KLOSS Mini can either be mounted on the wall individually or placed in rows on narrow steel frames, mirroring the options also available for the larger KLOSS bins.





Frame/Top/Wall bracket/Knob/Leg/Leg stand: Powder coated steel sheet

Lid: Powder coated steel sheet and compact laminate

Container: 100% recycled ABS plastic

Rubber insert: Black ECO EPDM rubber

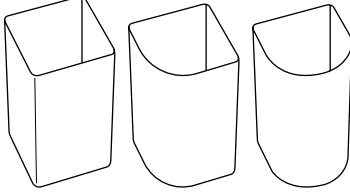
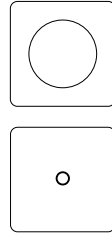
How to order KLOSS mini:

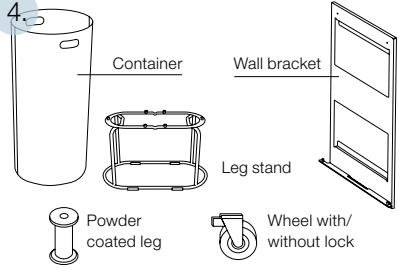
<p>1.</p> 	<p>2.</p> 	<p>3.</p> 	<p>4.</p> 
<p>Choose frame and colour Bin with adjustable feet. Integrated bag holder included.</p>	<p>Choose top and colour Soft closing fixed in powder-coated steel sheet.</p>	<p>Choose symbol Order more symbols per unit, if the product is to be placed on a standalone basis</p>	<p>Choose accessories: legs or wheels, wall bracket, lid, container and base insert. Integrated bag holder included in all models.</p>

KLOSS Mini Frame in powder coated steel sheet 1 mm. Width 200 mm, Height 320 mm, Depth 200 mm.

Markings on the illustrations refer to the visible mounting lines of the connection holes.

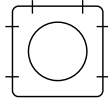

M1 Mini: Square frame

Holds approx. 13 L

Colour	Art no.
RAL 9010 White	32120001
RAL 7032 Warm Grey	32120020
RAL 7016 Anthracite	32120004
RAL 5023 Brilliant blue	32120021
RAL 1013 Pearl white	32120022
RAL 6013 Olive	32120023
RAL 6020 Forest green	32120024
RAL 8014 Chocolate	32120025
RAL 1017 Saffron	32120026
RAL 3014 Old pink	32120027
RAL 3005 Wine red	32120028

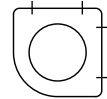

M2 Mini: Frame with one round corner

Holds approx. 12 L

Colour	Art no.
RAL 9010 White	32220001
RAL 7032 Warm Grey	32220020
RAL 7016 Anthracite	32220004
RAL 5023 Brilliant blue	32220021
RAL 1013 Pearl white	32220022
RAL 6013 Olive	32220023
RAL 6020 Forest green	32220024
RAL 8014 Chocolate	32220025
RAL 1017 Saffron	32220026
RAL 3014 Old pink	32220027
RAL 3005 Wine red	32220028

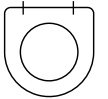

M3 Mini: Frame with a straight side and rounded front

Holds approx. 11 L

Colour	Art no.
RAL 9010 White	32320001
RAL 7032 Warm Grey	32320020
RAL 7016 Anthracite	32320004
RAL 5023 Brilliant blue	32320021
RAL 1013 Pearl white	32320022
RAL 6013 Olive	32320023
RAL 6020 Forest green	32320024
RAL 8014 Chocolate	32320025
RAL 1017 Saffron	32320026
RAL 3014 Old pink	32320027
RAL 3005 Wine red	32320028

Any RAL colour at an additional cost, contact TreCe.

KLOSS Mini Colours



Top: The Top is available in 4 variants with different external shapes, depending on the frame chosen. On the top of the fixed lid there is a knob in the same colour as the top and lid. The knob is designed and is only available from TreCe. Head Ø30mm x Foot Ø12mm

Lid: Powder coated steel sheet

KLOSS Mini M1 top

Square top in powder coated steel sheet 1,5 mm. Width 193 mm, Depth 193 mm.

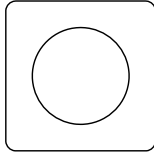

M1 Mini: Top

Hole Ø130 mm

Colour	Art no.
RAL 9010 White	32120201
RAL 7032 Warm Grey	32120220
RAL 7016 Anthracite	32120204
RAL 5023 Brilliant blue	32120221
RAL 1013 Pearl white	32120222
RAL 6013 Olive	32120223
RAL 6020 Forest green	32120224
RAL 8014 Chocolate	32120225
RAL 1017 Saffron	32120226
RAL 3014 Old pink	32120227
RAL 3005 Wine red	32120228

KLOSS Mini M2 top

Top in powder coated steel sheet 1,5 mm. Width 193 mm, Depth 193 mm.

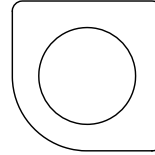

M2 Mini: Tpp

Hole Ø130 mm Ø130 mm

Colour	Art no.
RAL 9010 White	32220201
RAL 7032 Warm Grey	32220220
RAL 7016 Anthracite	32220204
RAL 5023 Brilliant blue	32220221
RAL 1013 Pearl white	32220222
RAL 6013 Olive	32220223
RAL 6020 Forest green	32220224
RAL 8014 Chocolate	32220225
RAL 1017 Saffron	32220226
RAL 3014 Old pink	32220227
RAL 3005 Wine red	32220228

KLOSS Mini M3 top

Top in powder coated steel sheet 1,5 mm. Width 193 mm, Depth 193 mm.

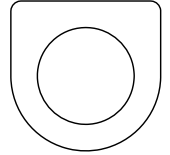

M3 Mini: Top

Hole Ø130 mm Ø130 mm

Colour	Art no.
RAL 9010 White	32320201
RAL 7032 Warm Grey	32320220
RAL 7016 Anthracite	32320204
RAL 5023 Brilliant blue	32320221
RAL 1013 Pearl white	32320222
RAL 6013 Olive	32320223
RAL 6020 Forest green	32320224
RAL 8014 Chocolate	32320225
RAL 1017 Saffron	32320226
RAL 3014 Old pink	32320227
RAL 3005 Wine red	32320228

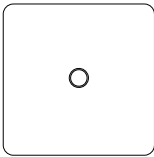

M1 Mini: Top

Full cover top with knob

Colour	Art no.
RAL 9010 White	32122101
RAL 7032 Warm Grey	32122120
RAL 7016 Anthracite	32122104
RAL 5023 Brilliant blue	32122121
RAL 1013 Pearl white	32122122
RAL 6013 Olive	32122123
RAL 6020 Forest green	32122124
RAL 8014 Chocolate	32122125
RAL 1017 Saffron	32122126
RAL 3014 Old pink	32122127
RAL 3005 Wine red	32122128

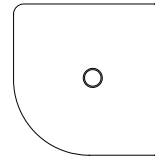

M2 Mini: Top

Full cover top with knob

Colour	Art no.
RAL 9010 White	32222101
RAL 7032 Warm Grey	32222120
RAL 7016 Anthracite	32222104
RAL 5023 Brilliant blue	32222121
RAL 1013 Pearl white	32222122
RAL 6013 Olive	32222123
RAL 6020 Forest green	32222124
RAL 8014 Chocolate	32222125
RAL 1017 Saffron	32222126
RAL 3014 Old pink	32222127
RAL 3005 Wine red	32222128

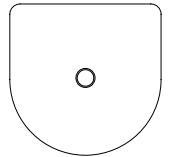

M3 Mini: Top

Full cover top with knob

Kulör	Art nr.
RAL 9010 White	32322101
RAL 7032 Warm Grey	32322120
RAL 7016 Anthracite	32322104
RAL 5023 Brilliant blue	32322121
RAL 1013 Pearl white	32322122
RAL 6013 Olive	32322123
RAL 6020 Forest green	32322124
RAL 8014 Chocolate	32322125
RAL 1017 Saffron	32322126
RAL 3014 Old pink	32322127
RAL 3005 Wine red	32322128

Any RAL colour at an additional cost. Contact TreCe

KLOSS Mini Symbol Ø80 mm, white or anthracite (factory mounted on the front frame)

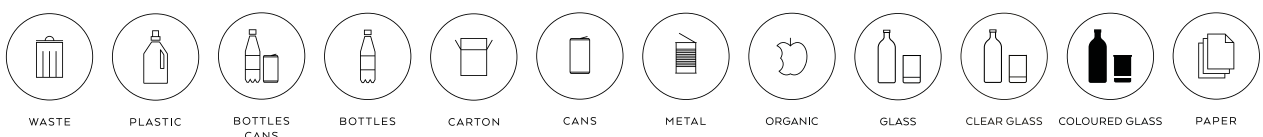

Colour	Art no.
White	32920101 32920201 32920301 32920401 32920501 32920601 32920701 32921001 32921301 32921101 32921201 32920901
Anthracite	32920104 32920204 32920304 32920404 32920504 32920604 32920704 32921004 32921304 32921104 32921204 32920904

See page 4 for reference

KLOSS Wall bracket, Mini Powder coated steel

Wall bracket Mini 1 frame

W:162 mm, H:302 mm, D:18 mm

Colour	Art no.
RAL 9010 White	32723101
RAL 7032 Warm Grey	32723120
RAL 7016 Anthracite	32723104
RAL 5023 Brilliant blue	32723121
RAL 1013 Pearl white	32723122
RAL 6013 Olive	32723123
RAL 6020 Forest green	32723124
RAL 8014 Chocolate	32723125
RAL 1017 Saffron	32723126
RAL 3014 Old pink	32723127
RAL 3005 Wine red	32723128

Wall bracket Mini 2 frame

W:363 mm, H:302 mm, D:18 mm

Colour	Art no.
RAL 9010 White	32723201
RAL 7032 Warm Grey	32723220
RAL 7016 Anthracite	32723204
RAL 5023 Brilliant blue	32723221
RAL 1013 Pearl white	32723222
RAL 6013 Olive	32723223
RAL 6020 Forest green	32723224
RAL 8014 Chocolate	32723225
RAL 1017 Saffron	32723226
RAL 3014 Old pink	32723227
RAL 3005 Wine red	32723228

KLOSS Mini with wall bracket

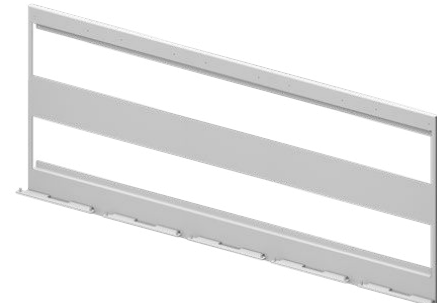
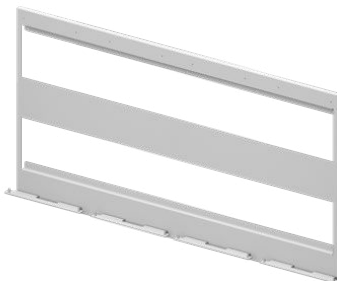
 Pearl white RAL 1013, Old pink RAL 3014,
 Wine red RAL 3005

Wall bracket Mini 3 frame

W:563 mm, H:302 mm, D:18 mm

Colour	Art no.
RAL 9010 White	32723301
RAL 7032 Warm Grey	32723320
RAL 7016 Anthracite	32723304
RAL 5023 Brilliant blue	32723321
RAL 1013 Pearl white	32723322
RAL 6013 Olive	32723323
RAL 6020 Forest green	32723324
RAL 8014 Chocolate	32723325
RAL 1017 Saffron	32723326
RAL 3014 Old pink	32723327
RAL 3005 Wine red	32723328

Wall bracket Mini 4 frame

W:764 mm, H:302 mm, D:18 mm

Colour	Art no.
RAL 9010 White	32723401
RAL 7032 Warm Grey	32723420
RAL 7016 Anthracite	32723404
RAL 5023 Brilliant blue	32723421
RAL 1013 Pearl white	32723422
RAL 6013 Olive	32723423
RAL 6020 Forest green	32723424
RAL 8014 Chocolate	32723425
RAL 1017 Saffron	32723426
RAL 3014 Old pink	32723427
RAL 3005 Wine red	32723428

Wall bracket Mini 5 frame

W:964 mm, H:302 mm, D:18 mm

Colour	Art no.
RAL 9010 White	32723501
RAL 7032 Warm Grey	32723520
RAL 7016 Anthracite	32723504
RAL 5023 Brilliant blue	32723521
RAL 1013 Pearl white	32723522
RAL 6013 Olive	32723523
RAL 6020 Forest green	32723524
RAL 8014 Chocolate	32723525
RAL 1017 Saffron	32723526
RAL 3014 Old pink	32723527
RAL 3005 Wine red	32723528

Any RAL colour at an additional cost. Contact TreCe



KLOSS Mini Pearl white RAL 1013 and Wine red RAL 3005 with leg stands

KLOSS Mini leg stand Powder coated steel wire Ø12 mm

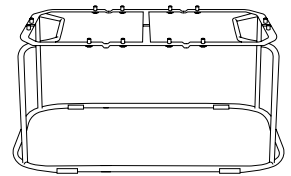
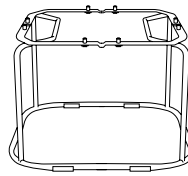
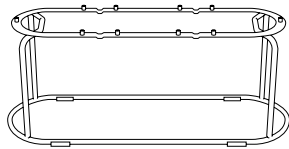
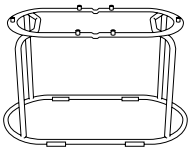

Kloss Mini Leg stand 2

W:400 mm, H:234 mm, D:200 mm

Fits 2 interconnected KLOSS Mini

Colour	Art no.
RAL 9010 White	32724101
RAL 7032 Warm Grey	32724120
RAL 7016 Anthracite	32724104
RAL 5023 Brilliant blue	32724121
RAL 1013 Pearl white	32724122
RAL 6013 Olive	32724123
RAL 6020 Forest green	32724124
RAL 8014 Chocolate	32724125
RAL 1017 Saffron	32724126
RAL 3014 Old pink	32724127
RAL 3005 Wine red	32724128

Kloss Mini Leg stand 3

W:600 mm, H:234 mm, D:200 mm

Fits 3 interconnected KLOSS Mini

Colour	Art no.
RAL 9010 White	32724201
RAL 7032 Warm Grey	32724220
RAL 7016 Anthracite	32724204
RAL 5023 Brilliant blue	32724221
RAL 1013 Pearl white	32724222
RAL 6013 Olive	32724223
RAL 6020 Forest green	32724224
RAL 8014 Chocolate	32724225
RAL 1017 Saffron	32724226
RAL 3014 Old pink	32724227
RAL 3005 Wine red	32724228

Kloss Mini Leg stand 4

W:400 mm, H:234 mm, D:400 mm

Fits 4 interconnected KLOSS Mini

Colour	Art no.
RAL 9010 White	32724301
RAL 7032 Warm Grey	32724320
RAL 7016 Anthracite	32724304
RAL 5023 Brilliant blue	32724321
RAL 1013 Pearl white	32724322
RAL 6013 Olive	32724323
RAL 6020 Forest green	32724324
RAL 8014 Chocolate	32724325
RAL 1017 Saffron	32724326
RAL 3014 Old pink	32724327
RAL 3005 Wine red	32724328

Kloss Mini Leg stand 6

W:600 mm, H:234 mm, D:400 mm

Fits 6 interconnected KLOSS Mini

Colour	Art no.
RAL 9010 White	32724401
RAL 7032 Warm Grey	32724420
RAL 7016 Anthracite	32724404
RAL 5023 Brilliant blue	32724421
RAL 1013 Pearl white	32724422
RAL 6013 Olive	32724423
RAL 6020 Forest green	32724424
RAL 8014 Chocolate	32724425
RAL 1017 Saffron	32724426
RAL 3014 Old pink	32724427
RAL 3005 Wine red	32724428

Any RAL colour at an additional cost. Contact TreCe

Leg: Powder coated steel sheet

Wheels: Black plain bearing wheels with nylon rim and rubber track. Black lacquered bracket

Container & Base insert: 100% recycled ABS plastic

Rubber insert: Black ECO EPDM rubber.

KLOSS Leg

The leg is designed and only available at TreCe. Powder coated in our standard colours.

Art.no. for KLOSS leg refers to 1 piece, adapt the number based on your complete set-up.

Dimensions: Ø48 x H85mm



Powder coated legs

Colour	Art no.
RAL 9010 White	32703001
RAL 7032 Warm Grey	32703020
RAL 7016 Anthracite	32703004
RAL 5023 Brilliant blue	32703021
RAL 1013 Pearl white	32703022
RAL 6013 Olive	32703023
RAL 6020 Forest green	32703024
RAL 8014 Chocolate	32703025
RAL 1017 Saffron	32703026
RAL 3014 Old pink	32703027
RAL 3005 Wine red	32703028

KLOSS Wheel

Art.no. for KLOSS wheel refers to 1 piece, adapt the number based on your complete set-up.

Black plain bearing wheel with nylon rim and rubber track. Black lacquered bracket.

Dimensions: Ø50 x H19mm



Wheel with and without brakes

Name	Description	Colour	Art no.
KLOSS Wheel	Without brake Load capacity 50 kg	Black	32705303
KLOSS Wheel	With brake Load capacity 50 kg Use 2 per setup	Black	32705403

Accessories: Fits all modules KLOSS Mini

Name	Description	Size (mm)	Colour	Art no.
Container mini	Approx. 6 L. Recycled ABS plastic 3 mm.	Ø166 x H287	Grey	32725003
Rubber insert	Reversible Glass/PET insert for KLOSS tops with Ø130 holes. Black ECO EPDM rubber.	Ø150	Black	32705203



Container Mini

Stackable container with handle

KLOSS Overview of placement of wheels & legs

The overview below shows the recommended number of wheels or legs per set-up. Both wheels and legs are sold individually. When ordering wheels, choose 2 of the wheels with brakes.

Singular basic units

Placement of legs or wheels

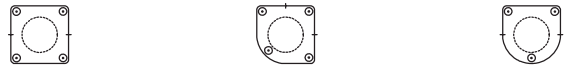

Selection of standard set-ups

Placements of legs or wheels (units on wheels are coupled)

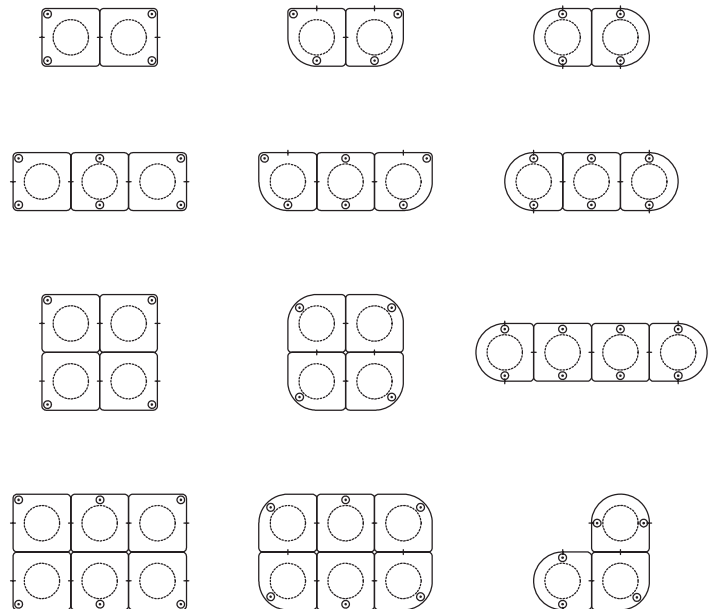

Accessories: Decal sheet

KLOSS decal sheet - Symbol Ø40 x H55mm (height of the whole decal)
Order if you want to add a symbol on the top/lid.

Description	Unit	Colour	Art no.
Decal sheet recycling - English text			
English, white text	21 pcs/ set	White	32706101
English, anthracite text	21 pcs/ set	Anthracite	32706104
Decal sheet recycling - Swedish text			
Swedish, white text	21 pcs/ set	White	32706201
Swedish, anthracite text	21 pcs/ set	Anthracite	32706204
Decal sheet recycling - Norwegian text			
Norwegian, white text	18 pcs/ set	White	32706301
Norwegian, anthracite text	18 pcs/ set	Anthracite	32706304

Examples of decals:

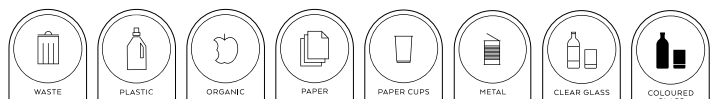

Please contact TreCe if you want other symbols or text in other languages.

Sustainability

QUICK FACTS

Content of the declaration	Certification TreCe	Certification TreCe
Environment	ISO 9001:2015	ISO 14001:2015
Country of manufacture	Recycled material	Recycled material
Sweden	20% of the steel sheet	100% recycled ABS plastic (container and base insert)



Byggarubedömning



KLOSS recycling system has been assessed by Byggarubedömningen and received the highest rating "Recommended".

BVB ID	167660
BSAB-code	XBD.6 - Containers, boxes and bins
BK04-codes	11213 Storage furniture 11299 Furniture other

This means that our assessed products are examined on chemical content, life-cycle, and sustainable supply chains. In this way we contribute to making it easier to build sustainably. Read more on byggvarubedomningen.com

SVHC/ECHA Candidate List

No chemicals on the ECHA Candidate List of SVHCs may be present in concentrations >0.1% by weight in the components, parts or chemicals used or incorporated in the manufacture of the furniture/product. See <http://echa.europa.eu/sv/candidate-list-table>

Metall – frame

The frame consists of cold-rolled steel sheet and is manufactured in Sweden. In the production of steel blanks, 20% recycled material is used and the remainder consists of iron raw material ore (80%). The steel sheet meets the requirements in Table 1.

Table 1: Metal requirements

Requirements	Complies with
Metals which come into direct contact with the skin over a long period of time (e.g. arm-rests) must not be made of alloys containing nickel, chromium III or chromium VI.	X

Powder coating

The powder coating method offers both environmental and quality benefits as no solvents need to be added and the amount of waste is very small. In addition, the powder coating provides a durable and attractive finish. Compliance is shown in Tables 2 and 3.

Table 2: Requirements for lacquer.

Requirements	Complies with
The content of aromatic solvents/hydrocarbons in coating products/preparations must not exceed 1.0% by weight.	X
Surface treatment with preparations containing VOCs may have a maximum applied VOC component of 60 g/m ² for office/public/outdoor environment.	X

Table 3: Hazard class and hazard designation according to Regulation 1272/2008

Faroclass	Indication of danger according to Regulation 1272/2008	Complies with
Acute toxicit	H300, H301, H310, H311, H330, H331	X
Organ toxic	H370, H371, H372, H373	X
Carcinogenic	H350, H351	X
Mutagenic	H340, H341	X
Toxic to reproduction	H360, H361, H362	X
Allergenic	H334	X
Environmentally hazardous	H400, H410, H411, H412, H413 If for technical reasons the use of coating products labelled as environmentally hazardous (H400, H410, H411, H412, H413) is required, it can be accepted if the applied amount is <14g/per m ² surface.	X
Hazardous to the ozone layer	H420	X

Plastic - Container and base insert

The container and base insert consists of 100% recycled ABS plastic and meets the requirements for plastic, see Table 4. recycling, we have permanently marked the bottom with the plastic type according to ISO 11469.

Table 4: Plastic requirements

Requirements	Complies with
Plastic parts >50 grams are permanently marked according to ISO 11469	X
Free from PVC (polyvinyl chloride)	X
Phthalates/softeners with hazard statement H340, H350, H360 must not be actively added or the measured value per substance and detail must not exceed 0,1 % by weight.	X
Short-chain chlorinated paraffins (SCCPs) must not be actively added or the measured value per substance and item must not exceed 0,01 % by weight.	X
The following flame retardants have not been actively added or the measured value per substance and detail shall not exceed 0,1 % by weight.	
Polybromerade bifenyler (PBBs) CAS-nr: 59536-65-1	
Dekabromdifenyler (dekaBDE) CAS-nr: 1163-19-5	
Pentabromdifenyler (pentaBDE) CAS-nr: 32534-81-9	
Oktabromdifenyler (oktaBDE) CAS-nr: 32536-52-0	
Tris (2,3-dibrompropyl) fosfat (TBPP) CAS-nr: 126-72-7	X
Tris (1-aziridinyl)fosfin oxid (TEPA) CAS-nr: 5455-55-1	
Hexabromcyklododekan (HBCDD) CAS-nr: 25637-99-4	
Tris (2 kloretyl) fosfat (TCEP) CAS-nr: 115-96-8	
Tris(1,3-dichloroisopropyl)phosphate (TDCPP) CAS-nr: 13674-87-8	
No pigments containing arsenic, lead, cadmium, tin, chromium VI or mercury are actively added or that their content does not exceed 0.01% by weight measured value per item.	X

Warranty: The warranty is valid from the date of delivery of the product. Invoice/order number must be quoted for the warranty to be valid. The warranty does not apply to products that have been stored or assembled incorrectly, used in an inappropriate or improper manner, altered in appearance/function or cleaned with an incorrect cleaning method or cleaning products. The warranty does not cover damage in transit, normal wear and tear, scratches, marks or damage caused by impact or accident. The warranty does not apply if the product has been placed outdoors or in a humid environment, or if the product has been used for purposes other than those for which it is intended.

For products intended for outdoor use, the aforementioned humid environment does not apply, but the warranty period is halved for installation within 200 metres of a coastal environment. The warranty does not apply to outdoor products where surface corrosion occurs over time as this is purely aesthetic and can be remedied with touch-up paint.

General care instructions

Metal

Wipe with a slightly damp, soft lint-free cloth and mild detergent. Always wipe dry with a dry cloth. Never use solvents on painted metal or abrasive materials.