



INTERIOR
DESIGN



archiproducts®
AWARDS
WINNER

KLOSS

Design | Kauppi & Kauppi



KLOSS Recycling System reflects our evolving need to separate and organise materials, ensuring that what was once considered waste is now treated as a valuable resource for reuse. Every space has unique conditions, and with KLOSS, the possibilities are virtually limitless. You can create any form or function you need, in any RAL colour of your choice. These are creative, playful recycling units designed for all environments.

"Modularity" is the basic idea and design essence of KLOSS. A vast and highly flexible, connectable modular system for recycling.

Three different modules, made of steel, provide endless possibilities and shapes. Choice of modules and configuration, together with the choice of colour, top, lid and accessories - gives the recycling unit its final shape and expression.

KLOSS can either blend seamlessly into its surroundings or become a standout feature, depending on the chosen size, composition, colour, and accessories.

The KLOSS recycling system is also available in two other sizes with several new features - KLOSS Small and KLOSS Mini, this expansion elevates KLOSS into a comprehensive infrastructure of recycling furniture.

See separate product sheets for KLOSS Mini and Small.



KLOSS recycling system has been assessed by Byggarbedömningen and received the highest rating "Recommended".



Last updated: 2024.11.26



Sustainability and materials

- The modules are made of 20 % recycled steel with long durability.
- Circular product: modules can be disassembled and replaced, refreshed, repaired, refurbished and recycled.
- The steel body is made in parts that are joined together by the click method and are detachable for renovation.
- Container with base insert allows the use of paper bag.
- Container and base insert is made of 100 % recycled ABS plastic.
- The rubber inlet is made of black bio-based ECO EPDM rubber.
- KLOSS can hold up to 62-68 L
- EPD



KLOSS Olive RAL 6013

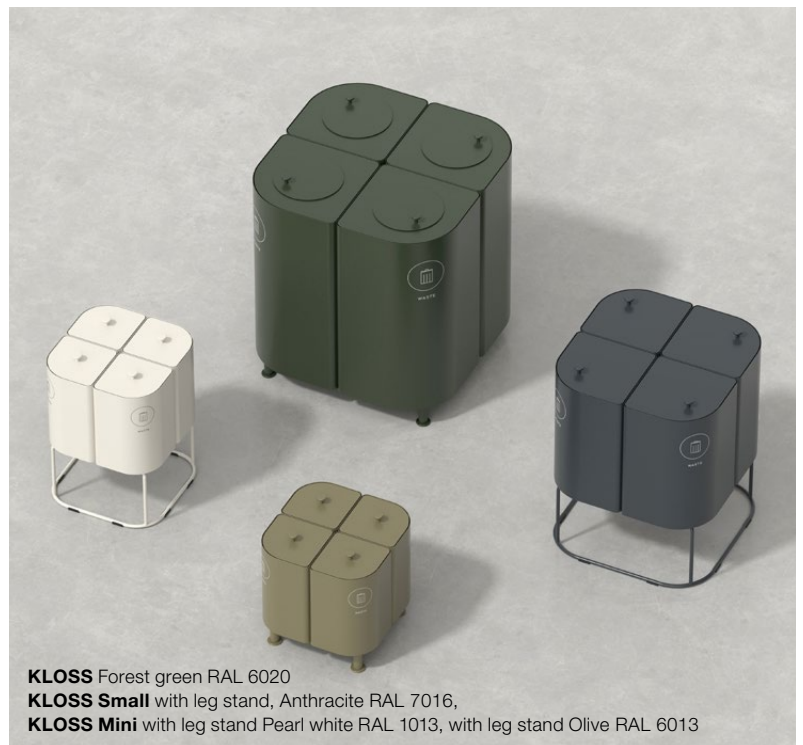

KLOSS Forest green RAL 6020
KLOSS Small with leg stand, Anthracite RAL 7016,
KLOSS Mini with leg stand Pearl white RAL 1013, with leg stand Olive RAL 6013



KLOSS are attached together with connection holes on each frame

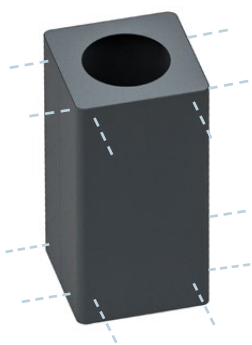

M1 - 6 connection holes



M2 - 4 connection holes



M3 - 2 connection holes

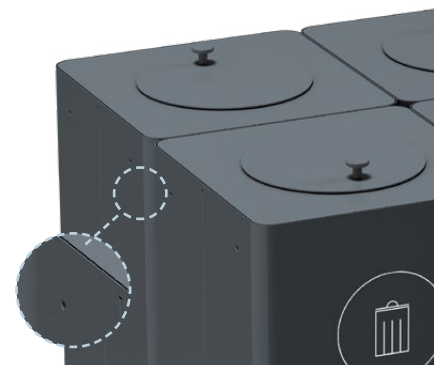

NOTE! The connection holes are included on all our frames and will be visible depending on which set you have.



Frame/Top/Wall bracket/Knob/Leg: Powder coated steel sheet

Lid: Powder coated steel sheet and compact laminate

Container & Base insert: 100% recycled ABS plastic

Rubber insert: Black ECO EPDM rubber

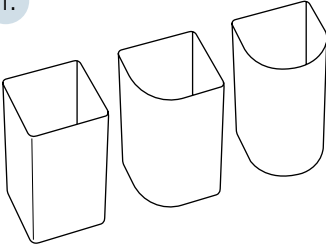
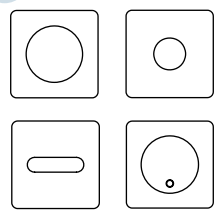
How to order KLOSS:

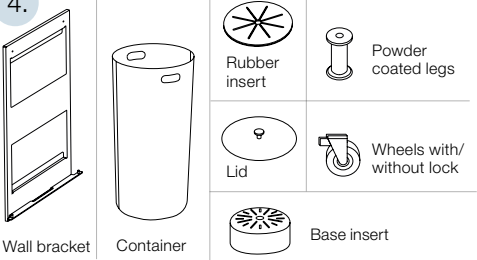
<p>1.</p> 	<p>2.</p> 	<p>3.</p> 	<p>4.</p> 
<p>Choose frame and colour Bin with adjustable feet. Integrated bag holder included.</p>	<p>Choose top and colour Available with lid & lock.</p>	<p>Choose symbol Order more symbols per unit, if the product is to be placed on a standalone basis</p>	<p>Choose accessories: legs or wheels, wall bracket, lid, container and base insert. Integrated bag holder included in all models.</p>

KLOSS Frame in powder coated steel sheet 1 mm. Width 360 mm, Height 700 mm, Depth 360 mm.

Markings on the illustrations refer to the visible mounting lines of the connection holes.

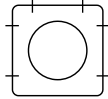

M1: Square frame

Holds approx. 68 L

Colour	Art no.
RAL 9010 White	32100001
RAL 7032 Warm Grey	32100020
RAL 7016 Anthracite	32100004
RAL 5023 Brilliant blue	32100021
RAL 1013 Pearl white	32100022
RAL 6013 Olive	32100023
RAL 6020 Forest green	32100024
RAL 8014 Chocolate	32100025
RAL 1017 Saffron	32100026
RAL 3014 Old pink	32100027
RAL 3005 Wine red	32100028

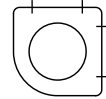

M2: Frame with one round corner

Holds approx. 65 L

Colour	Art no.
RAL 9010 White	32200001
RAL 7032 Warm Grey	32200020
RAL 7016 Anthracite	32200004
RAL 5023 Brilliant blue	32200021
RAL 1013 Pearl white	32200022
RAL 6013 Olive	32200023
RAL 6020 Forest green	32200024
RAL 8014 Chocolate	32200025
RAL 1017 Saffron	32200026
RAL 3014 Old pink	32200027
RAL 3005 Wine red	32200028

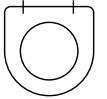

M3: Frame with a straight side and rounded front

Holds approx. 62 L

Colour	Art no.
RAL 9010 White	32300001
RAL 7032 Warm Grey	32300020
RAL 7016 Anthracite	32300004
RAL 5023 Brilliant blue	32300021
RAL 1013 Pearl white	32300022
RAL 6013 Olive	32300023
RAL 6020 Forest green	32300024
RAL 8014 Chocolate	32300025
RAL 1017 Saffron	32300026
RAL 3014 Old pink	32300027
RAL 3005 Wine red	32300028

Any RAL colour at an additional cost, contact TreCe.

KLOSS Colours



White Warm Grey Anthracite Brilliant blue Pearl white Olive Forest green Chocolate Saffron Old pink Wine red

Top: The Top is available in 4 variants with different external shapes, depending on the frame chosen. On the top of the fixed lid there is a knob in the same colour as the top and lid. The knob is designed and is only available from TreCe. Head Ø30mm x Foot Ø12mm

Lid: Powder coated steel sheet

KLOSS M1 Square top in powder coated steel sheet 2 mm. Width 352 mm, Height 12 mm, Depth 352 mm.

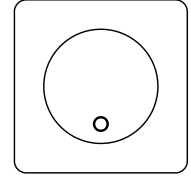
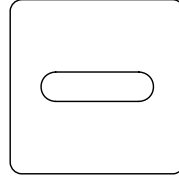
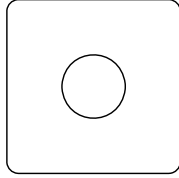
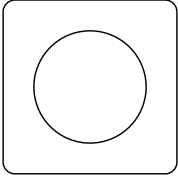

M1: Top

Hole Ø220 mm

Colour	Art no.
RAL 9010 White	32100101
RAL 7032 Warm Grey	32100120
RAL 7016 Anthracite	32100104
RAL 5023 Brilliant blue	32100121
RAL 1013 Pearl white	32100122
RAL 6013 Olive	32100123
RAL 6020 Forest green	32100124
RAL 8014 Chocolate	32100125
RAL 1017 Saffron	32100126
RAL 3014 Old pink	32100127
RAL 3005 Wine red	32100128

M1: Top

Hole Ø130 mm

Colour	Art no.
RAL 9010 White	32100201
RAL 7032 Warm Grey	32100220
RAL 7016 Anthracite	32100204
RAL 5023 Brilliant blue	32100221
RAL 1013 Pearl white	32100222
RAL 6013 Olive	32100223
RAL 6020 Forest green	32100224
RAL 8014 Chocolate	32100225
RAL 1017 Saffron	32100226
RAL 3014 Old pink	32100227
RAL 3005 Wine red	32100228

M1: Top

Oblong hole 60*230 mm

Colour	Art no.
RAL 9010 White	32100301
RAL 7032 Warm Grey	32100320
RAL 7016 Anthracite	32100304
RAL 5023 Brilliant blue	32100321
RAL 1013 Pearl white	32100322
RAL 6013 Olive	32100323
RAL 6020 Forest green	32100324
RAL 8014 Chocolate	32100325
RAL 1017 Saffron	32100326
RAL 3014 Old pink	32100327
RAL 3005 Wine red	32100328

M1: Top

Fixed lid with knob Ø235mm, hole Ø210mm

Colour	Art no.
RAL 9010 White	32100401
RAL 7032 Warm Grey	32100420
RAL 7016 Anthracite	32100404
RAL 5023 Brilliant blue	32100421
RAL 1013 Pearl white	32100422
RAL 6013 Olive	32100423
RAL 6020 Forest green	32100424
RAL 8014 Chocolate	32100425
RAL 1017 Saffron	32100426
RAL 3014 Old pink	32100427
RAL 3005 Wine red	32100428

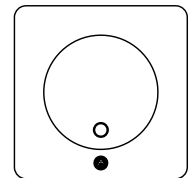
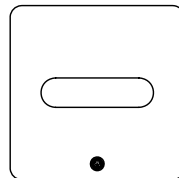
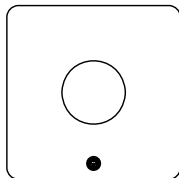
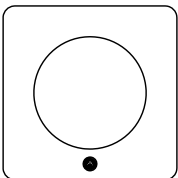

M1: Top with triangular lock

Hole Ø220 mm

Colour	Art no.
RAL 9010 White	32101101
RAL 7032 Warm Grey	32101120
RAL 7016 Anthracite	32101104
RAL 5023 Brilliant blue	32101121
RAL 1013 Pearl white	32101122
RAL 6013 Olive	32101123
RAL 6020 Forest green	32101124
RAL 8014 Chocolate	32101125
RAL 1017 Saffron	32101126
RAL 3014 Old pink	32101127
RAL 3005 Wine red	32101128

M1: Top with triangular lock

Hole Ø130 mm

Colour	Art no.
RAL 9010 White	32101201
RAL 7032 Warm Grey	32101220
RAL 7016 Anthracite	32101204
RAL 5023 Brilliant blue	32101221
RAL 1013 Pearl white	32101222
RAL 6013 Olive	32101223
RAL 6020 Forest green	32101224
RAL 8014 Chocolate	32101225
RAL 1017 Saffron	32101226
RAL 3014 Old pink	32101227
RAL 3005 Wine red	32101228

M1: Top with triangular lock

Oblong hole 60*230 mm

Colour	Art no.
RAL 9010 White	32101301
RAL 7032 Warm Grey	32101320
RAL 7016 Anthracite	32101304
RAL 5023 Brilliant blue	32101321
RAL 1013 Pearl white	32101322
RAL 6013 Olive	32101323
RAL 6020 Forest green	32101324
RAL 8014 Chocolate	32101325
RAL 1017 Saffron	32101326
RAL 3014 Old pink	32101327
RAL 3005 Wine red	32101328

M1: Top with triangular lock

Fixed lid with knob Ø235mm, hole Ø210mm

Colour	Art no.
RAL 9010 White	32101401
RAL 7032 Warm Grey	32101420
RAL 7016 Anthracite	32101404
RAL 5023 Brilliant blue	32101421
RAL 1013 Pearl white	32101422
RAL 6013 Olive	32101423
RAL 6020 Forest green	32101424
RAL 8014 Chocolate	32101425
RAL 1017 Saffron	32101426
RAL 3014 Old pink	32101427
RAL 3005 Wine red	32101428

Any RAL colour at an additional cost. Contact TreCe

Triangular key included when ordering top with lock. Can also be purchased separately.

Top: The Top is available in 4 variants with different external shapes, depending on the frame chosen. On the top of the fixed lid there is a knob in the same colour as the top and lid. The knob is designed and is only available from TreCe. Head Ø30mm x Foot Ø12mm

Lid: Powder coated steel sheet

KLOSS M2 Top in powder coated steel sheet 2 mm. Width 352 mm, Height 12 mm, Depth 352 mm.

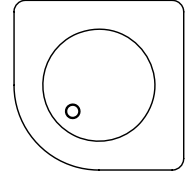
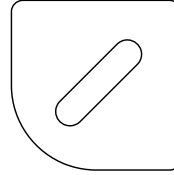
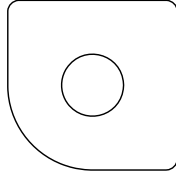
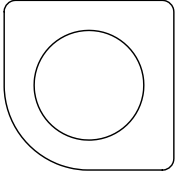

M2: Top

Hole Ø220 mm

Colour	Art no.
RAL 9010 White	32200101
RAL 7032 Warm Grey	32200120
RAL 7016 Anthracite	32200104
RAL 5023 Brilliant blue	32200121
RAL 1013 Pearl white	32200122
RAL 6013 Olive	32200123
RAL 6020 Forest green	32200124
RAL 8014 Chocolate	32200125
RAL 1017 Saffron	32200126
RAL 3014 Old pink	32200127
RAL 3005 Wine red	32200128

M2: Top

Hole Ø130 mm

Colour	Art no.
RAL 9010 White	32200201
RAL 7032 Warm Grey	32200220
RAL 7016 Anthracite	32200204
RAL 5023 Brilliant blue	32200221
RAL 1013 Pearl white	32200222
RAL 6013 Olive	32200223
RAL 6020 Forest green	32200224
RAL 8014 Chocolate	32200225
RAL 1017 Saffron	32200226
RAL 3014 Old pink	32200227
RAL 3005 Wine red	32200228

M2: Top

Oblong hole 60*230 mm

Colour	Art no.
RAL 9010 White	32200301
RAL 7032 Warm Grey	32200320
RAL 7016 Anthracite	32200304
RAL 5023 Brilliant blue	32200321
RAL 1013 Pearl white	32200322
RAL 6013 Olive	32200323
RAL 6020 Forest green	32200324
RAL 8014 Chocolate	32200325
RAL 1017 Saffron	32200326
RAL 3014 Old pink	32200327
RAL 3005 Wine red	32200328

M2: Top

Fixed lid with knob Ø235mm, hole Ø210mm

Colour	Art no.
RAL 9010 White	32200401
RAL 7032 Warm Grey	32200420
RAL 7016 Anthracite	32200404
RAL 5023 Brilliant blue	32200421
RAL 1013 Pearl white	32200422
RAL 6013 Olive	32200423
RAL 6020 Forest green	32200424
RAL 8014 Chocolate	32200425
RAL 1017 Saffron	32200426
RAL 3014 Old pink	32200427
RAL 3005 Wine red	32200428

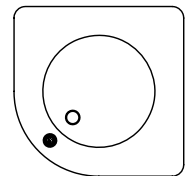
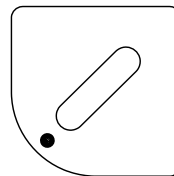
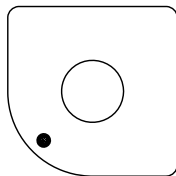
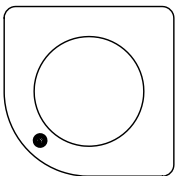

M2: Top with triangular lock

Hole Ø220 mm

Colour	Art no.
RAL 9010 White	32201101
RAL 7032 Warm Grey	32201120
RAL 7016 Anthracite	32201104
RAL 5023 Brilliant blue	32201121
RAL 1013 Pearl white	32201122
RAL 6013 Olive	32201123
RAL 6020 Forest green	32201124
RAL 8014 Chocolate	32201125
RAL 1017 Saffron	32201126
RAL 3014 Old pink	32201127
RAL 3005 Wine red	32201128

M2: Top with triangular lock

Hole Ø130 mm

Colour	Art no.
RAL 9010 White	32201201
RAL 7032 Warm Grey	32201220
RAL 7016 Anthracite	32201204
RAL 5023 Brilliant blue	32201221
RAL 1013 Pearl white	32201222
RAL 6013 Olive	32201223
RAL 6020 Forest green	32201224
RAL 8014 Chocolate	32201225
RAL 1017 Saffron	32201226
RAL 3014 Old pink	32201227
RAL 3005 Wine red	32201228

M2: Top with triangular lock

Oblong hole 60*230 mm

Colour	Art no.
RAL 9010 White	32201301
RAL 7032 Warm Grey	32201320
RAL 7016 Anthracite	32201304
RAL 5023 Brilliant blue	32201321
RAL 1013 Pearl white	32201322
RAL 6013 Olive	32201323
RAL 6020 Forest green	32201324
RAL 8014 Chocolate	32201325
RAL 1017 Saffron	32201326
RAL 3014 Old pink	32201327
RAL 3005 Wine red	32201328

M2: Top with triangular lock

Fixed lid with knob Ø235mm, hole Ø210mm

Colour	Art no.
RAL 9010 White	32201401
RAL 7032 Warm Grey	32201420
RAL 7016 Anthracite	32201404
RAL 5023 Brilliant blue	32201421
RAL 1013 Pearl white	32201422
RAL 6013 Olive	32201423
RAL 6020 Forest green	32201424
RAL 8014 Chocolate	32201425
RAL 1017 Saffron	32201426
RAL 3014 Old pink	32201427
RAL 3005 Wine red	32201428

Any RAL colour at an additional cost. Contact TreCe

Triangular key included when ordering top with lock. Can also be purchased separately.

Top: The Top is available in 4 variants with different external shapes, depending on the frame chosen. On the top of the fixed lid there is a knob in the same colour as the top and lid. The knob is designed and is only available from TreCe. Head Ø30mm x Foot Ø12mm

Lid: Powder coated steel sheet

KLOSS M3 Top in powder coated steel sheet 2 mm. Width 352 mm, Height 12 mm, Depth 352 mm.

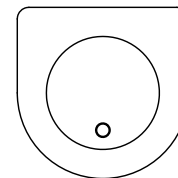
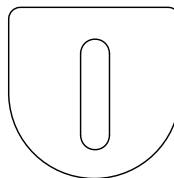
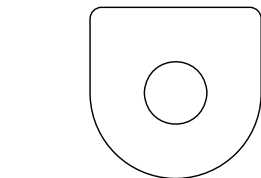
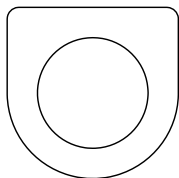

M3: Top

Hole Ø220 mm

Colour	Art no.
RAL 9010 White	32300101
RAL 7032 Warm Grey	32300120
RAL 7016 Anthracite	32300104
RAL 5023 Brilliant blue	32300121
RAL 1013 Pearl white	32300122
RAL 6013 Olive	32300123
RAL 6020 Forest green	32300124
RAL 8014 Chocolate	32300125
RAL 1017 Saffron	32300126
RAL 3014 Old pink	32300127
RAL 3005 Wine red	32300128

M3: Top

Hole Ø130 mm

Colour	Art no.
RAL 9010 White	32300201
RAL 7032 Warm Grey	32300220
RAL 7016 Anthracite	32300204
RAL 5023 Brilliant blue	32300221
RAL 1013 Pearl white	32300222
RAL 6013 Olive	32300223
RAL 6020 Forest green	32300224
RAL 8014 Chocolate	32300225
RAL 1017 Saffron	32300226
RAL 3014 Old pink	32300227
RAL 3005 Wine red	32300228

M3: Top

Oblong hole 60*230 mm

Colour	Art no.
RAL 9010 White	32300301
RAL 7032 Warm Grey	32300320
RAL 7016 Anthracite	32300304
RAL 5023 Brilliant blue	32300321
RAL 1013 Pearl white	32300322
RAL 6013 Olive	32300323
RAL 6020 Forest green	32300324
RAL 8014 Chocolate	32300325
RAL 1017 Saffron	32300326
RAL 3014 Old pink	32300327
RAL 3005 Wine red	32300328

M3: Top

Fixed lid with knob Ø235mm, hole Ø210mm

Colour	Art no.
RAL 9010 White	32300401
RAL 7032 Warm Grey	32300420
RAL 7016 Anthracite	32300404
RAL 5023 Brilliant blue	32300421
RAL 1013 Pearl white	32300422
RAL 6013 Olive	32300423
RAL 6020 Forest green	32300424
RAL 8014 Chocolate	32300425
RAL 1017 Saffron	32300426
RAL 3014 Old pink	32300427
RAL 3005 Wine red	32300428

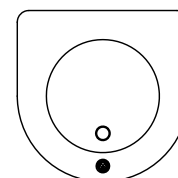
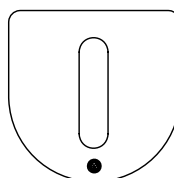
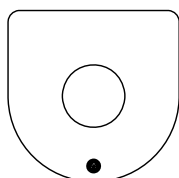
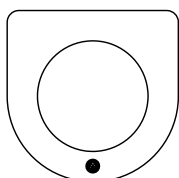

M3: Top with triangular lock

Hole Ø220 mm

Colour	Art no.
RAL 9010 White	32301101
RAL 7032 Warm Grey	32301120
RAL 7016 Anthracite	32301104
RAL 5023 Brilliant blue	32301121
RAL 1013 Pearl white	32301122
RAL 6013 Olive	32301123
RAL 6020 Forest green	32301124
RAL 8014 Chocolate	32301125
RAL 1017 Saffron	32301126
RAL 3014 Old pink	32301127
RAL 3005 Wine red	32301128

M3: Top with triangular lock

Hole Ø130 mm

Colour	Art no.
RAL 9010 White	32301201
RAL 7032 Warm Grey	32301220
RAL 7016 Anthracite	32301204
RAL 5023 Brilliant blue	32301221
RAL 1013 Pearl white	32301222
RAL 6013 Olive	32301223
RAL 6020 Forest green	32301224
RAL 8014 Chocolate	32301225
RAL 1017 Saffron	32301226
RAL 3014 Old pink	32301227
RAL 3005 Wine red	32301228

M3: Top with triangular lock

Oblong hole 60*230 mm

Colour	Art no.
RAL 9010 White	32301301
RAL 7032 Warm Grey	32301320
RAL 7016 Anthracite	32301304
RAL 5023 Brilliant blue	32301321
RAL 1013 Pearl white	32301322
RAL 6013 Olive	32301323
RAL 6020 Forest green	32301324
RAL 8014 Chocolate	32301325
RAL 1017 Saffron	32301326
RAL 3014 Old pink	32301327
RAL 3005 Wine red	32301328

M3: Top with triangular lock

Fixed lid with knob Ø235mm, hole Ø210mm

Colour	Art no.
RAL 9010 White	32301401
RAL 7032 Warm Grey	32301420
RAL 7016 Anthracite	32301404
RAL 5023 Brilliant blue	32301421
RAL 1013 Pearl white	32301422
RAL 6013 Olive	32301423
RAL 6020 Forest green	32301424
RAL 8014 Chocolate	32301425
RAL 1017 Saffron	32301426
RAL 3014 Old pink	32301427
RAL 3005 Wine red	32301428

Any RAL colour at an additional cost. Contact TreCe

Triangular key included when ordering top with lock. Can also be purchased separately.

Top: The compact laminate top is available in 3 different versions depending on the frame chosen.

Lid: Lid in compact laminate with knob powder coated RAL according to the table below. The knob is designed and only available at TreCe.
Head Ø30mm x Foot Ø12 mm



KLOSS Top Compact laminate with black core, H352 x D12 x W352

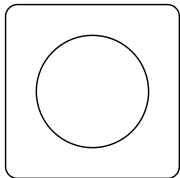

M1: Top compact laminate

Hole Ø220 mm

Colour	Colour	Art no.
F2297 Terril	Anthracite	32100161
F2255 Polar White	White	32100162
F5343 Possum	Olive grey	32100163

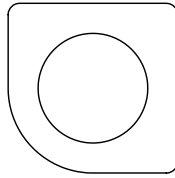

M2: Top compact laminate

Hole Ø220 mm

Colour	Colour	Art no.
F2297 Terril	Anthracite	32200161
F2255 Polar White	White	32200162
F5343 Possum	Olive grey	32200163

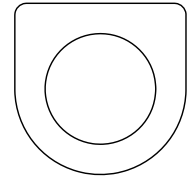

M2: Top compact laminate

Hole Ø220 mm

Colour	Colour	Art no.
F2297 Terril	Anthracite	32300161
F2255 Polar White	White	32300162
F5343 Possum	Olive grey	32300163

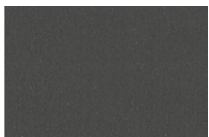

Anthracite (F2297)



White (F2255)



Olive grey (F5343)

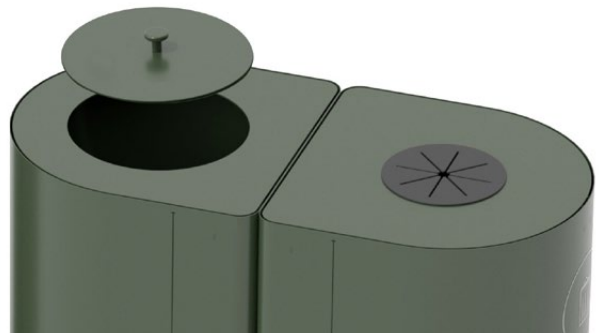

*The rubber insert fits in tops that have a Ø130 hole.
It is removable for cleaning and reversible.

KLOSS Lock Compact laminate with black core

Including KLOSS knob

Hole Ø220 mm

Colour	Colour	Knob/Colour	Art no.
F2297 Terril	Anthracite	RAL 7016	32700261
F2255 Polar White	White	RAL 9010	32700262
F5343 Possum	Olive grey	RAL 6013	32700263



Wall mount: Powder coated steel sheet

KLOSS Symbol Ø120 mm, white or anthracite (factory mounted on the front frame)

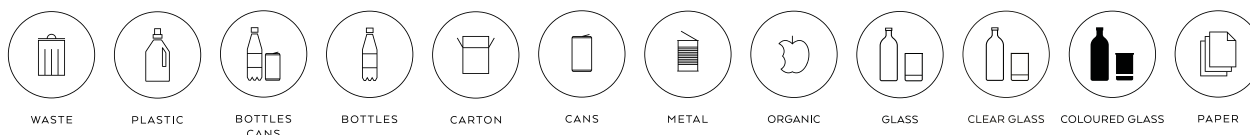

Colour	Art no.											
White	32900101	32900201	32900301	32900401	32900501	32900601	32900701	32901001	32901301	32901101	32901201	32900901
Anthracite	32900104	32900204	32900304	32900404	32900504	32900604	32900704	32901004	32901304	32901104	32901204	32900904

See page 4 for reference



KLOSS Wall bracket Powder coated steel sheet



Wall bracket 1 frame

W:276 mm, D:18 mm, H:702 mm

Colour	Art no.
RAL 9010 White	32703101
RAL 7032 Warm Grey	32703120
RAL 7016 Anthracite	32703104
RAL 5023 Brilliant blue	32703121
RAL 1013 Pearl white	32703122
RAL 6013 Olive	32703123
RAL 6020 Forest green	32703124
RAL 8014 Chocolate	32703125
RAL 1017 Saffron	32703126
RAL 3014 Old pink	32703127
RAL 3005 Wine red	32703128



Wall bracket 2 frame

W:637 mm, D:18 mm, H:702 mm

Colour	Art no.
RAL 9010 White	32703201
RAL 7032 Warm Grey	32703220
RAL 7016 Anthracite	32703204
RAL 5023 Brilliant blue	32703221
RAL 1013 Pearl white	32703222
RAL 6013 Olive	32703223
RAL 6020 Forest green	32703224
RAL 8014 Chocolate	32703225
RAL 1017 Saffron	32703226
RAL 3014 Old pink	32703227
RAL 3005 Wine red	32703228

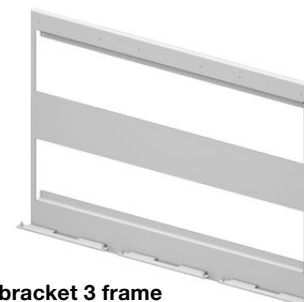

Wall bracket 3 frame

W:998 mm, D:18 mm, H:702 mm

Colour	Art no.
RAL 9010 White	32703301
RAL 7032 Warm Grey	32703320
RAL 7016 Anthracite	32703304
RAL 5023 Brilliant blue	32703321
RAL 1013 Pearl white	32703322
RAL 6013 Olive	32703323
RAL 6020 Forest green	32703324
RAL 8014 Chocolate	32703325
RAL 1017 Saffron	32703326
RAL 3014 Old pink	32703327
RAL 3005 Wine red	32703328

Contact TreCe if more than 3 KLOSS are to be mounted next to each other, spacer template available.

Any RAL colour for an additional charge, contact TreCe.

Leg: Powder coated steel sheet

Wheels: Black plain bearing wheels with nylon rim and rubber track. Black lacquered bracket



Powder coated adjustable legs.



Wheels, with or without brakes.



Without legs or wheels, small adjustable feet are included.

KLOSS Leg

The legs is designed and only available at TreCe.
Powder coated in our standard colours.



Powder coated leg, adjustable

Art.no. for KLOSS leg refers to 1 piece, adapt the number based on your complete set-up.

Dimensions: Ø48 x H85mm

Colour	Art no.
RAL 9010 White	32703001
RAL 7032 Warm Grey	32703020
RAL 7016 Anthracite	32703004
RAL 5023 Brilliant blue	32703021
RAL 1013 Pearl white	32703022
RAL 6013 Olive	32703023
RAL 6020 Forest green	32703024
RAL 8014 Chocolate	32703025
RAL 1017 Saffron	32703026
RAL 3014 Old pink	32703027
RAL 3005 Wine red	32703028

KLOSS Overview of placement of wheels & legs

The overview below shows the recommended number of wheels or legs per set-up. Both wheels and legs are sold individually. When ordering wheels, choose 2 of the wheels with brakes.

Singular basic units

Placement of legs or wheels

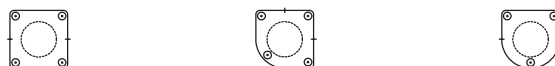

Selection of standard set-ups

Placements of legs or wheels (units on wheels are coupled)

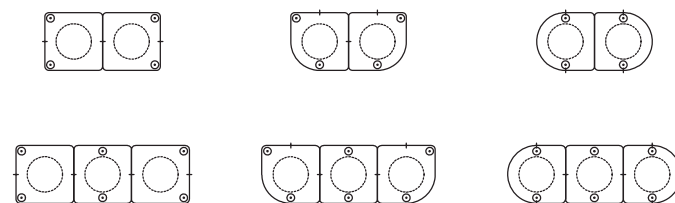

KLOSS Wheel

Art.no. for KLOSS wheel refers to 1 piece, adapt the number based on your complete set-up. Black plain bearing wheel with nylon rim and rubber track. Black lacquered bracket.



Wheel with and without brakes

Dimensions: Ø50 x H19mm

Name	Description	Colour	Art no.
KLOSS Wheel	Without brake Load capacity 50 kg	Black	32705303
KLOSS Wheel	With brake Load capacity 50 kg Use 2 per setup	Black	32705403

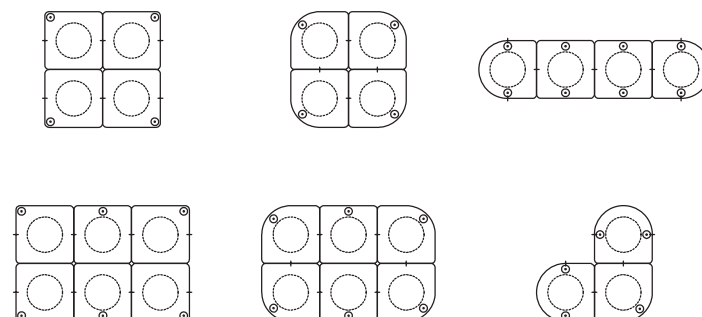

Container & Base insert: 100% recycled ABS plastic

Rubber insert: Black ECO EPDM rubber.

Accessories: Fits all modules

Product	Description	Size	Colour	Art no.
Container	Approx. 45L. Handle W80 x H30mm. Recycled ABS plastic 3 mm.	Ø320 x H650	Grey	32705003
Base insert	Insert with perforated grid Recycled ABS plastic 3 mm.	Ø240 x H100	Grey	32705103
Triangular key	Extra key for tops with lock.	W50 x H80	Silver	32705203
Garbage bag	85 L, 25 pcs/roll		Black	321699
Rubber insert	Reversible Glass/PET insert for KLOSS tops with Ø130 holes. Black ECO EPDM rubber.	Ø150	Black	321610

Container 45 L and base insert.

Base insert is used as bottom insert in the container. The perforated grid is anchored to ventilate moisture.

Add the base insert when using food waste bags as they often have a lower depth.

Stackable container with handle.



Triangular key

Rubber insert

Accessories: Decal sheet

KLOSS decal sheet - Symbol Ø40 x H55mm (height of the whole decal)

Order if you want to add a symbol on the top/lid.

Description	Unit	Colour	Art no.
Decal sheet recycling - English text			
English, white text	21 pcs/ set	White	32706101
English, anthracite text	21 pcs/ set	Anthracite	32706104
Decal sheet recycling - Swedish text			
Swedish, white text	21 pcs/ set	White	32706201
Swedish, anthracite text	21 pcs/ set	Anthracite	32706204
Decal sheet recycling - Norwegian text			
Norwegian, white text	18 pcs/ set	White	32706301
Norwegian, anthracite text	18 pcs/ set	Anthracite	32706304

Please contact TreCe if you want other symbols or text in other languages.



Sustainability

QUICK FACTS

Content of the declaration	Certification TreCe	Certification TreCe
Environment	ISO 9001:2015	ISO 14001:2015
Country of manufacture	Recycled material	Recycled material
Sweden	Steel sheet 20% recycled pre-consumer	100% recycled pre-consumer ABS plastic
GWP-fossil kg CO ₂ e		
54,04844 kg		



EPD



KLOSS also has an EPD, which provides a transparent and detailed report on the environmental impact of a product throughout its life cycle. It allows you to compare materials and make informed and sustainable choices. Check the full EPD here: [KLOSS - EPD](#)

Byggarubedömning



KLOSS recycling system has been assessed by Byggarubedömningen and received the highest rating "Recommended".

BVB ID	167660
BSAB-code	XBD.6 - Containers, boxes and bins
BK04-codes	11213 Storage furniture 11299 Furniture other

This means that our assessed products are examined on chemical content, life-cycle, and sustainable supply chains. In this way we contribute to making it easier to build sustainably. Read more on byggvarubedomningen.com

SVHC/ECHA Candidate List

No chemicals on the ECHA Candidate List of SVHCs may be present in concentrations >0.1% by weight in the components, parts or chemicals used or incorporated in the manufacture of the furniture/product. See <http://echa.europa.eu/sv/candidate-list-table>

Metall

The metal meets the requirements in table 1. The frame consist of cold-rolled steel plate and are manufactured in Sweden. In the production of steel blank, 20 % recycled pre-consumer material is used together with iron raw material ore (80 %).

Table 1: Metal requirements

Requirements	Complies with
Metals which come into direct contact with the skin over a long period of time (e.g. arm-rests) must not be made of alloys containing nickel, chromium III or chromium VI.	X

Powder coating

The powder coating method offers both environmental and quality benefits as no solvents need to be added and the amount of waste is very small. In addition, the powder coating provides a durable and attractive finish. Compliance is shown in Tables 2 and 3.

Table 2: Requirements for lacquer.

Requirements	Complies with
The content of aromatic solvents/hydrocarbons in coating products/preparations must not exceed 1.0% by weight.	X
Surface treatment with preparations containing VOCs may have a maximum applied VOC component of 60 g/m ² for office/public/outdoor environment.	X

Table 3: Hazard class and hazard designation according to Regulation 1272/2008

Faroclass	Indication of danger according to Regulation 1272/2008	Complies with
Acute toxicit	H300, H301, H310, H311, H330, H331	X
Organ toxic	H370, H371, H372, H373	X
Carcinogenic	H350, H351	X
Mutagenic	H340, H341	X
Toxic to reproduction	H360, H361, H362	X
Allergenic	H334	X
Environmentally hazardous	H400, H410, H411, H412, H413 If for technical reasons the use of coating products labelled as environmentally hazardous (H400, H410, H411, H412, H413) is required, it can be accepted if the applied amount is <14g/per m ² surface.	X
Hazardous to the ozone layer	H420	X

Plastic - Container and base insert

The container and base insert consists of 100% recycled ABS plastic and meets the requirements for plastic, see Table 4. recycling, we have permanently marked the bottom with the plastic type according to ISO 11469.

Table 4: Plastic requirements

Requirements	Complies with
Plastic parts >50 grams are permanently marked according to ISO 11469	X
Free from PVC (polyvinyl chloride)	X
Phthalates/softeners with hazard statement H340, H350, H360 must not be actively added or the measured value per substance and detail must not exceed 0,1 % by weight.	X
Short-chain chlorinated paraffins (SCCPs) must not be actively added or the measured value per substance and item must not exceed 0,01 % by weight.	X
The following flame retardants have not been actively added or the measured value per substance and detail shall not exceed 0,1 % by weight.	
Polybromerade bifenyler (PBBs)	CAS-nr: 59536-65-1
Dekabromdifenyler (dekaBDE)	CAS-nr: 1163-19-5
Pentabromdifenyler (pentaBDE)	CAS-nr: 32534-81-9
Oktabromdifenyler (oktaBDE)	CAS-nr: 32536-52-0
Tris (2,3-dibrompropyl) fosfat (TBPP)	CAS-nr: 126-72-7
Tris (1-aziridinyl)fosfin oxid (TEPA)	CAS-nr: 5455-55-1
Hexabromcyklododekan (HBCDD)	CAS-nr: 25637-99-4
Tris (2 kloretyl) fosfat (TCEP)	CAS-nr: 115-96-8
Tris(1,3-dichloroisopropyl)phosphate (TDCPP)	CAS-nr: 13674-87-8
No pigments containing arsenic, lead, cadmium, tin, chromium VI or mercury are actively added or that their content does not exceed 0.01% by weight measured value per item.	X

Warranty: The warranty is valid from the date of delivery of the product. Invoice/order number must be quoted for the warranty to be valid. The warranty does not apply to products that have been stored or assembled incorrectly, used in an inappropriate or improper manner, altered in appearance/function or cleaned with an incorrect cleaning method or cleaning products. The warranty does not cover damage in transit, normal wear and tear, scratches, marks or damage caused by impact or accident. The warranty does not apply if the product has been placed outdoors or in a humid environment, or if the product has been used for purposes other than those for which it is intended.

For products intended for outdoor use, the aforementioned humid environment does not apply, but the warranty period is halved for installation within 200 metres of a coastal environment. The warranty does not apply to outdoor products where surface corrosion occurs over time as this is purely aesthetic and can be remedied with touch-up paint.

General care instructions

Metal

Wipe with a slightly damp, soft lint-free cloth and mild detergent. Always wipe dry with a dry cloth.
Never use solvents on painted metal or abrasive materials.